



School of Physics and Astronomy

Fourier Analysis

Prof. John A. Peacock

jap@roe.ac.uk

Session: 2014/15

1 Introduction

Describing continuous signals as a superposition of waves is one of the most useful concepts in physics, and features in many branches – acoustics, optics, quantum mechanics for example. The most common and useful technique is the *Fourier* technique, which were invented by Joseph Fourier in the early 19th century. In many cases of relevance in physics, the equations involved are linear: this means that different waves satisfying the equation can be added to generate a new solution, in which the waves evolve independently. This allows solutions to be found for many ordinary differential equations (ODEs) and partial differential equations (PDEs). We will also explore some other techniques for solving common equations in physics, such as Green’s functions, and separation of variables, and investigate some aspects of digital sampling of signals.

As a reminder of notation, a single wave mode might have the form

$$\psi(x) = a \cos(kx + \phi). \tag{1.1}$$

Here, a is the wave *amplitude*; ϕ is the *phase*; and k is the *wavenumber*, where the *wavelength* is $\lambda = 2\pi/k$. Equally, we might have a function that varies in time: then we would deal with $\cos\omega t$, where ω is *angular frequency* and the *period* is $T = 2\pi/\omega$. In what follows, we will tend to assume that the waves are functions of x , but this is an arbitrary choice: the mathematics will apply equally well to functions of time.

2 Introduction to the Dirac delta function

But before we can get on with Fourier analysis, it is necessary to take a short detour, to introduce a function that will be used a great deal later in this course – but which is required immediately by some of the other physics courses. This is the *Dirac delta function*, which is opposite extreme of an oscillating function such as $\cos kx$: such a wave extends infinitely far with no reduction in the strength of oscillation, but a delta-function represents an effect that is entirely localised or instantaneous – sometimes called an *impulse*. Informally, it is to be thought of as an infinitely narrow (and infinitely tall) spike. Mathematicians think it’s not a proper function, since a function is a machine, $f(x)$, that takes any number x and replaces it with a well-defined number $f(x)$. Dirac didn’t care, and used it anyway. Eventually, the ‘theory of distributions’ was invented to say he was right to follow his intuition.

2.1 Definition and basic properties

The Dirac delta function $\delta(x - d)$ is defined by *two* expressions. First, it is zero everywhere except at the point $x = d$ where it is infinite:

$$\delta(x - d) = \begin{cases} 0 & \text{for } x \neq d, \\ \rightarrow \infty & \text{for } x = d. \end{cases} \tag{2.2}$$

Secondly, it tends to infinity at $x = d$ in such a way that the area under the Dirac delta function is unity:

$$\int_{-\infty}^{\infty} dx \delta(x - d) = 1. \tag{2.3}$$

2.1.1 The delta function as a limiting case

To see how a spike of zero width can have a well-defined area, it is helpful (although not strictly necessary) to think of the delta function as the limit of a more familiar function. The exact shape of this function doesn't matter, except that it should look more and more like a (normalized) spike as we make it narrower. The simplest possibility is the 'top-hat' function, which is zero if $|x| > a$ and has height $h = 1/(2a)$ for smaller $|x|$, so that it is *normalized* with unit area. Let $\Pi_a(x)$ be a normalized top-hat of width $2a$ centred at $x = 0$ as in Eqn. (4.15) — we've made the width parameter obvious by putting it as a subscript here. The Dirac delta function can then be represented as

$$\delta(x) = \lim_{a \rightarrow 0} \Pi_a(x) . \quad (2.4)$$

Similarly, $\delta(x - c)$ is a spike centred at $x = c$ (it has to be centred at whatever value of x makes the argument of the function vanish); this can be represented as a top-hat centred at $x = c$.

2.2 Sifting property

The *sifting property* of the Dirac delta function is that, given some function $f(x)$:

$$\int_{-\infty}^{\infty} dx \delta(x - d) f(x) = f(d) \quad (2.5)$$

i.e. the delta function picks out the value of the function at the position of the spike (so long as it is within the integration range). This is just like the sifting property of the Kronecker delta inside a discrete sum.

2.2.1 Compare with the Kronecker delta

The Kronecker delta

$$\delta_{mn} = \begin{cases} 1 & m = n \\ 0 & m \neq n \end{cases} \quad (2.6)$$

plays a similar sifting role for discrete modes, as the Dirac delta does for continuous modes. For example:

$$\sum_{n=1}^{\infty} A_n \delta_{mn} = A_m \quad (2.7)$$

which is obvious when you look at it. Be prepared to do this whenever you see a sum with a Kronecker delta in it.

2.2.2 Proving the sifting property

We can use the representation of the Dirac delta function at the limit of a top-hat to prove the sifting property:

$$\int_{-\infty}^{\infty} dx f(x) \delta(x) = \int_{-\infty}^{\infty} dx f(x) \lim_{a \rightarrow 0} \Pi_a(x) = \lim_{a \rightarrow 0} \int_{-\infty}^{\infty} dx f(x) \Pi_a(x) . \quad (2.8)$$

We are free to pull the limit outside the integral because nothing else depends on a . Substituting for $\Pi_a(x)$, the integral is only non-zero between $-a$ and a . Similarly, we can pull the normalization

factor out to the front:

$$\int_{-\infty}^{\infty} dx f(x) \delta(x) = \lim_{a \rightarrow 0} \frac{1}{2a} \int_{-a}^a dx f(x). \quad (2.9)$$

What this is doing is averaging f over a narrow range of width $2a$ around $x = 0$. Provided the function is *continuous*, this will converge to a well-defined value $f(0)$ as $a \rightarrow 0$ (this is pretty well the definition of continuity).

3 Fourier Series

Learning outcomes

In this section we will learn how Fourier series (real and complex) can be used to represent functions and sum series. We will also see what happens when we use truncated Fourier series as an approximation to the original function, including the Gibbs phenomenon for discontinuous functions.

3.1 Overview

Fourier series are a way of expressing a function as a sum, or *linear superposition*, of waves of different frequencies:

$$f(x) = \sum_i a_i \cos(k_i x + \phi_i). \quad (3.10)$$

This becomes more well specified if we consider the special case where the function is *periodic* with a period $2L$. This requirement means that we can only consider waves where a whole number of wavelengths fit into $2L$: $2L = n\lambda \Rightarrow k = n\pi/L$. Unfortunately, this means we will spend a lot of time writing $n\pi/L$, making the formulae look more complicated than they really are. Once you are confident, it is clearer to write $n\pi/L$ just as k_n .

A further simplification is to realize that the phase of the waves need not be dealt with explicitly. This is because of the trigonometric identity (which you should know)

$$\cos(A + B) = \cos(A) \cos(B) - \sin(A) \sin(B). \quad (3.11)$$

Thus a single wave mode of given phase can be considered to be the combination of a sin and a cos mode, both of zero phase.

- Fourier Series deal with functions that are *periodic* over a *finite interval*. e.g. $-1 < x < 1$. The function is assumed to repeat outside this interval.
- Fourier Series are useful if (a) the function really is periodic, or (b) we only care about the function in a finite range (e.g. $-\pi < x < \pi$). We'll discuss this more in Sec. 3.7.
- If the range is infinite, we can use a Fourier Transform (see section 4).
- We can decompose *any* function we like in this way (well, any that satisfy some very mild mathematical restrictions).
- The sines and cosines are said to form a *complete set*. This means the same as the last bullet point. We won't prove this.

- One can decompose functions in other complete sets of functions (e.g. powers: the Taylor series is an example of this), but the Fourier Series is perhaps the most common and useful. Most of this course will be concerned with Fourier Series and Fourier Transforms (see later).

3.2 Periodic Functions

Periodic functions satisfy

$$f(t + T) = f(t) \quad (3.12)$$

for all t . T is then the period. Similarly, a function can be periodic in space: $f(x + X) = f(x)$.

Exercise: Show that if $f(t)$ and $g(t)$ are periodic with period T , then so are $af(t) + bg(t)$ and $cf(t)g(t)$, where a, b, c are constants.

Note that a function which is periodic with a period X is also periodic with period $2X$, and indeed periodic with period nX , for any integer n . The *smallest* period is called the *fundamental period*.

Note also that the function does not have to be continuous.

Examples:

- $\sin x$ and $\cos x$ both have a fundamental period of 2π .
- $\sin\left(\frac{n\pi x}{L}\right)$ has a period of $2L/n$, where n is an integer.
- So $\sin\left(\frac{n\pi x}{L}\right)$ and $\cos\left(\frac{n\pi x}{L}\right)$ all have periods $2L$ as well as $2L/n$ (for all integer n).
- Note that the boundary of the period can be anything convenient: $0 \leq x \leq 2L$ for example, or $a \leq x \leq a + 2L$ for any a . Since it is periodic, it doesn't matter.

3.3 The Fourier expansion

Within the interval $-L \leq x \leq L$, we can write a general (real-valued) function as a *linear superposition* of these Fourier modes:

$$\begin{aligned} f(x) &= \frac{1}{2}a_0 + \sum_{n=1}^{\infty} a_n \cos\left(\frac{n\pi x}{L}\right) + \sum_{n=1}^{\infty} b_n \sin\left(\frac{n\pi x}{L}\right) \\ &= \frac{1}{2}a_0 + \sum_{n=1}^{\infty} \left[a_n \cos\left(\frac{n\pi x}{L}\right) + b_n \sin\left(\frac{n\pi x}{L}\right) \right] \end{aligned} \quad (3.13)$$

where a_n and b_n are (real-valued) *expansion coefficients*, also known as *Fourier components*. The reason for the unexpected factor $1/2$ multiplying a_0 will be explained below.

3.3.1 What about $n < 0$?

We don't need to include negative n because the Fourier modes have a well defined symmetry (even or odd) under $n \rightarrow -n$: let's imagine we included negative n and that the expansion coefficients

are A_n and B_n :

$$f(x) = \frac{A_0}{2} + \sum_{\pm n} \left[A_n \cos\left(\frac{n\pi x}{L}\right) + B_n \sin\left(\frac{n\pi x}{L}\right) \right] \quad (3.14)$$

$$= \frac{A_0}{2} + \sum_{n=1}^{\infty} \left[A_n \cos\left(\frac{n\pi x}{L}\right) + A_{-n} \cos\left(\frac{-n\pi x}{L}\right) + B_n \sin\left(\frac{n\pi x}{L}\right) + B_{-n} \sin\left(\frac{-n\pi x}{L}\right) \right]. \quad (3.15)$$

Now, $\cos\left(-\frac{n\pi x}{L}\right) = \cos\left(\frac{n\pi x}{L}\right)$ and $\sin\left(-\frac{n\pi x}{L}\right) = -\sin\left(\frac{n\pi x}{L}\right)$, so we can rewrite this as

$$f(x) = \frac{A_0}{2} + \sum_{n=1}^{\infty} \left[(A_n + A_{-n}) \cos\left(\frac{n\pi x}{L}\right) + (B_n - B_{-n}) \sin\left(\frac{n\pi x}{L}\right) \right]. \quad (3.16)$$

At this point A_n and A_{-n} are unknown constants. As they only appear summed together (rather than separately) we may as well just rename them as a single, unknown constant $a_0 = A_0$, $a_n \equiv A_n + A_{-n}$, ($n \geq 1$). We do the same for $b_n \equiv B_n - B_{-n}$. So, overall it is sufficient to consider just positive values of n in the sum.

FOURIER ANALYSIS: LECTURE 2

3.4 Orthogonality

Having written a function as a sum of Fourier modes, we would like to be able to calculate the components. This is made easy because the Fourier mode functions are *orthogonal* i.e. for non-zero integers m and n ,

$$\int_{-L}^L dx \cos\left(\frac{m\pi x}{L}\right) \cos\left(\frac{n\pi x}{L}\right) = \begin{cases} 0 & m \neq n \\ L & m = n \end{cases} \quad (3.17)$$

$$\int_{-L}^L dx \sin\left(\frac{m\pi x}{L}\right) \sin\left(\frac{n\pi x}{L}\right) = \begin{cases} 0 & m \neq n \\ L & m = n \end{cases} \quad (3.18)$$

$$\int_{-L}^L dx \cos\left(\frac{m\pi x}{L}\right) \sin\left(\frac{n\pi x}{L}\right) = 0. \quad (3.19)$$

You can do the integrals using the trigonometry identities in Eqn. (3.23) below. Note that one of the Fourier modes is a constant (the $a_0/2$ term), so we will also need

$$\int_{-L}^L dx \cos\left(\frac{n\pi x}{L}\right) = \begin{cases} 0 & n \neq 0 \\ 2L & n = 0 \end{cases} \quad (3.20)$$

$$\int_{-L}^L dx \sin\left(\frac{n\pi x}{L}\right) = 0 \quad (3.21)$$

Note the appearance of $2L$ here, rather than L in the $n > 0$ cases above.

The orthogonality is the fact that we get zero in each case if $m \neq n$. We refer to the collected Fourier modes as an *orthogonal set* of functions.

Let us show one of these results. If $m \neq n$,

$$\begin{aligned}
 \int_{-L}^L dx \cos\left(\frac{m\pi x}{L}\right) \cos\left(\frac{n\pi x}{L}\right) &= \frac{1}{2} \int_{-L}^L dx \left[\cos\left\{\frac{(m+n)\pi x}{L}\right\} + \cos\left\{\frac{(m-n)\pi x}{L}\right\} \right] \\
 &= \frac{1}{2} \left[\frac{L \sin\left\{\frac{(m+n)\pi x}{L}\right\}}{(m+n)\pi} + \frac{L \sin\left\{\frac{(m-n)\pi x}{L}\right\}}{(m-n)\pi} \right]_{-L}^L \\
 &= 0 \quad \text{if } m \neq n.
 \end{aligned} \tag{3.22}$$

If $m = n$, the second cosine term is $\cos 0 = 1$, which integrates to L .

ASIDE: useful trigonometric relations To prove the orthogonality, the following formulæ are useful:

$$\begin{aligned}
 2 \cos A \cos B &= \cos(A + B) + \cos(A - B) \\
 2 \sin A \cos B &= \sin(A + B) + \sin(A - B) \\
 2 \sin A \sin B &= -\cos(A + B) + \cos(A - B) \\
 2 \cos A \sin B &= \sin(A + B) - \sin(A - B)
 \end{aligned} \tag{3.23}$$

To derive these, we write $e^{i(A \pm B)} = e^{iA} e^{\pm iB}$, and rewrite each exponential using $e^{\pm i\theta} = \cos \theta \pm i \sin \theta$. Add or subtract the two \pm expressions and take real or imaginary parts as appropriate to get each of the four results. Alternatively, the orthogonality can be proved using the complex representation directly: $\cos(kx) = [\exp(ikx) + \exp(-ikx)]/2$, so a product of cosines always generates oscillating terms like $\exp(-ix\Delta k)$; these always integrate to zero, unless $\Delta k = 0$.

3.5 Calculating the Fourier components

The Fourier basis functions are always the same. When we expand different functions as Fourier series, the difference lies in the values of the expansion coefficients. To calculate these Fourier components we exploit the orthogonality proved above. The approach will be the same as we follow when we extract components of vectors, which are expressed as a sum of components times basis functions: $\mathbf{v} = \sum_i a_i \mathbf{e}_i$. The basis vectors are orthonormal, so we extract the j^{th} component just by taking the dot product with \mathbf{e}_j to project along that direction:

$$\mathbf{e}_j \cdot \mathbf{v} = \mathbf{e}_j \cdot \sum_i a_i \mathbf{e}_i = a_j. \tag{3.24}$$

This works because all the terms in the series give zero, except the one we want. The procedure with Fourier series is exactly analogous:

1. Choose which constant we wish to calculate (i.e. a_m or b_m for some fixed, chosen value of m)
2. Multiply both sides by the corresponding Fourier mode (e.g. $\cos\left(\frac{m\pi x}{L}\right)$ if we are interested in a_m or $\sin\left(\frac{m\pi x}{L}\right)$ if we are trying to find b_m)
3. Integrate over the full range ($-L \leq x \leq L$ in this case)
4. Rearrange to get the answer.

So, to get a_m :

$$\int_{-L}^L dx \cos\left(\frac{m\pi x}{L}\right) f(x) \quad (3.25)$$

$$= \frac{1}{2} a_0 \int_{-L}^L dx \cos\left(\frac{m\pi x}{L}\right) \quad (3.26)$$

$$+ \sum_{n=1}^{\infty} \left[a_n \int_{-L}^L dx \cos\left(\frac{m\pi x}{L}\right) \cos\left(\frac{n\pi x}{L}\right) + b_n \int_{-L}^L dx \cos\left(\frac{m\pi x}{L}\right) \sin\left(\frac{n\pi x}{L}\right) \right] \quad (3.27)$$

$$= a_0 \cdot L \delta_{m0} + \sum_{n=1}^{\infty} L a_n \delta_{mn} \quad (3.28)$$

$$= L a_m. \quad (3.29)$$

$$(3.30)$$

δ_{mn} is the *Kronecker delta function*:

$$\delta_{mn} = \begin{cases} 1 & m = n \\ 0 & m \neq n \end{cases} \quad (3.31)$$

Rearranging:

$$a_m = \frac{1}{L} \int_{-L}^L dx \cos\left(\frac{m\pi x}{L}\right) f(x) \quad (3.32)$$

$$\text{Similarly, } b_m = \frac{1}{L} \int_{-L}^L dx \sin\left(\frac{m\pi x}{L}\right) f(x). \quad (3.33)$$

So this is why the constant term is defined as $a_0/2$: it lets us use the above expression for a_m for all values of m , including zero.

3.6 Even and odd expansions

What if the function we wish to expand is even: $f(-x) = f(x)$, or odd: $f(-x) = -f(x)$? Because the Fourier modes are also even ($\cos\left(\frac{n\pi x}{L}\right)$) or odd ($\sin\left(\frac{n\pi x}{L}\right)$), we can simplify the Fourier expansions.

3.6.1 Expanding an even function

Consider first the case that $f(x)$ is even:

$$b_m = \frac{1}{L} \int_{-L}^L dx \sin\left(\frac{m\pi x}{L}\right) f(x) = \frac{1}{L} \int_0^L dx \sin\left(\frac{m\pi x}{L}\right) f(x) + \frac{1}{L} \int_{-L}^0 dx \sin\left(\frac{m\pi x}{L}\right) f(x) \quad (3.34)$$

In the second integral, make a change of variables $y = -x \Rightarrow dy = -dx$. The limits on y are $L \rightarrow 0$, and use this minus sign to switch them round to $0 \rightarrow L$. $f(x) = f(-y) = +f(y)$ because it is an even function, whereas $\sin\left(-\frac{m\pi y}{L}\right) = -\sin\left(\frac{m\pi y}{L}\right)$ as it is odd. Overall, then:

$$b_m = \frac{1}{L} \int_0^L dx \sin\left(\frac{m\pi x}{L}\right) f(x) - \frac{1}{L} \int_0^L dy \sin\left(\frac{m\pi y}{L}\right) f(y) = 0 \quad (3.35)$$

i.e. the Fourier decomposition of an even function contains only even Fourier modes. Similarly, we can show that

$$a_m = \frac{1}{L} \int_0^L dx \cos\left(\frac{m\pi x}{L}\right) f(x) + \frac{1}{L} \int_0^L dy \cos\left(\frac{m\pi y}{L}\right) f(y) = \frac{2}{L} \int_0^L dx \cos\left(\frac{m\pi x}{L}\right) f(x). \quad (3.36)$$

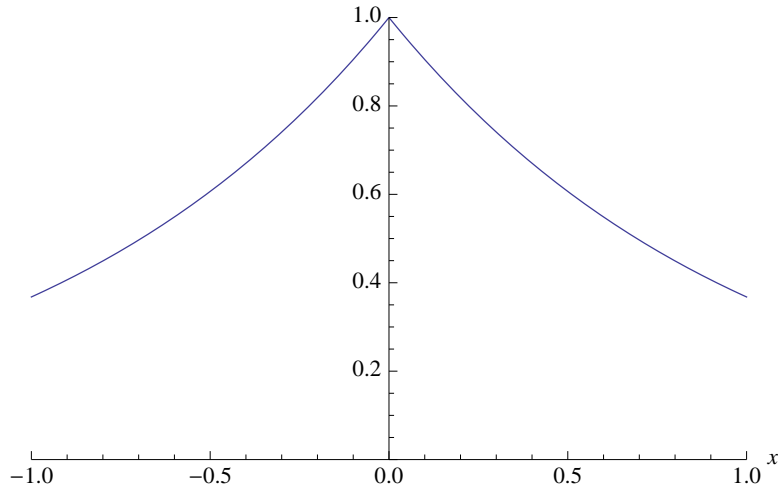

Figure 3.1: $e^{-|x|}$ in $-1 < x < 1$.

3.6.2 Expanding an odd function

For an odd function we get a similar result: all the a_m vanish, so we only get odd Fourier modes, and we can calculate the b_m by doubling the result from integrating from $0 \rightarrow L$:

$$a_m = 0 \tag{3.37}$$

$$b_m = \frac{2}{L} \int_0^L dx \sin\left(\frac{m\pi x}{L}\right) f(x) \tag{3.38}$$

We derive these results as before: split the integral into regions of positive and negative x ; make a transformation $y = -x$ for the latter; exploit the symmetries of $f(x)$ and the Fourier modes $\cos\left(\frac{m\pi x}{L}\right)$, $\sin\left(\frac{m\pi x}{L}\right)$.

Example: $f(x) = e^{-|x|}$ for $-1 < x < 1$. The fundamental period is 2.

The function is symmetric, so we seek a cosine series, with $L = 1$:

$$\begin{aligned} a_m &= \frac{2}{L} \int_0^L dx \cos\left(\frac{m\pi x}{L}\right) f(x) \\ &= 2 \int_0^1 dx \cos(m\pi x) e^{-x} \\ &= 2 \int_0^1 dx \frac{1}{2} (e^{im\pi x} + e^{-im\pi x}) e^{-x} \\ &= \int_0^1 dx (e^{im\pi x - x} + e^{-im\pi x - x}) \\ &= \left[\frac{e^{(im\pi - 1)x}}{im\pi - 1} + \frac{e^{-(im\pi + 1)x}}{-(im\pi + 1)} \right]_0^1 \end{aligned} \tag{3.39}$$

$$\tag{3.40}$$

Now $e^{im\pi} = (e^{i\pi})^m = (-1)^m$, and similarly $e^{-im\pi} = (-1)^m$, so (noting that there is a contribution

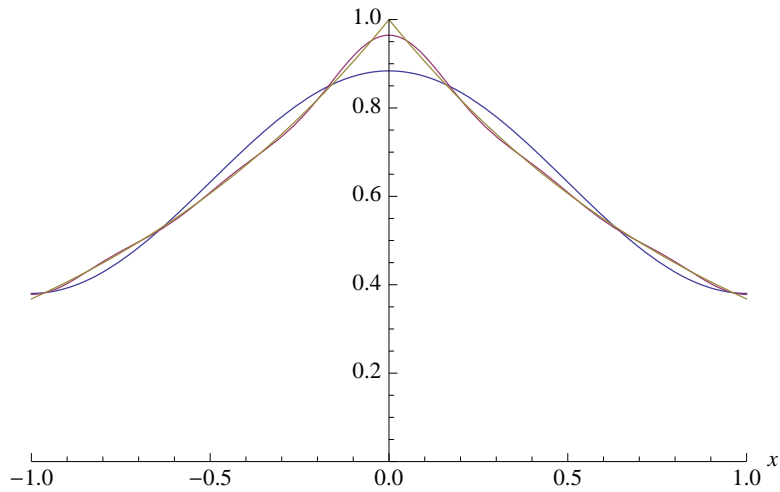

Figure 3.2: Fourier Series for $e^{-|x|}$ in $-1 < x < 1$ summed up to $m = 1$ and to $m = 5$.

from $x = 0$)

$$\begin{aligned}
 a_m &= \frac{(-1)^m e^{-1} - 1}{im\pi - 1} - \frac{(-1)^m e^{-1} - 1}{im\pi + 1} \\
 &= [(-1)^m e^{-1} - 1] \left[\frac{1}{im\pi - 1} - \frac{1}{im\pi + 1} \right] \\
 &= [(-1)^m e^{-1} - 1] \frac{2}{(im\pi - 1)(im\pi + 1)} \\
 &= \frac{2[(-1)^m e^{-1} - 1]}{-m^2\pi^2 - 1} \\
 &= \frac{2[1 - (-1)^m e^{-1}]}{1 + m^2\pi^2}.
 \end{aligned} \tag{3.41}$$

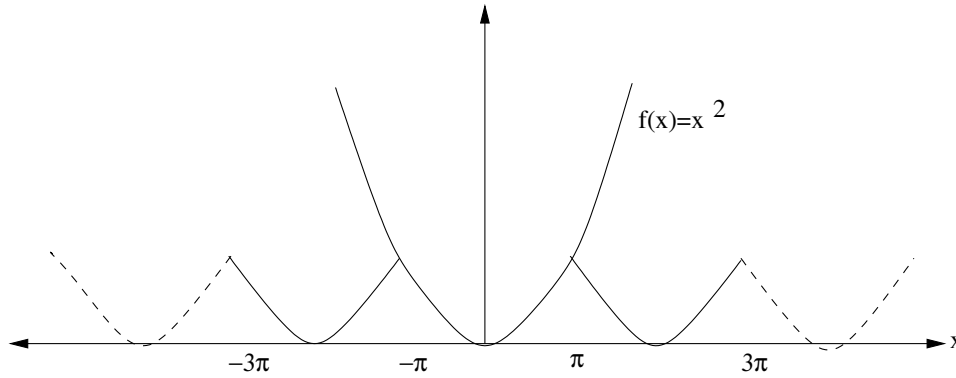

Figure 3.3: $f(x) = x^2$ as a periodic function.

FOURIER ANALYSIS: LECTURE 3

3.7 Periodic extension, or what happens outside the range?

To discuss this, we need to be careful to distinguish between the original function that we expanded $f(x)$ (which is defined for all x) and the Fourier series expansion $f_{\text{FS}}(x)$ that we calculated (which is valid only for $-L \leq x \leq L$).

Inside the expansion range $f_{\text{FS}}(x)$ is guaranteed to agree exactly with $f(x)$. Outside this range, the Fourier expansion $f_{\text{FS}}(x)$ will not, in general, agree with $f(x)$.

As an example, let's expand the function $f(x) = x^2$ between $-L$ and L (L is some number, which we might decide to set equal to π). This is an *even* function so we know $b_n = 0$. The other coefficients are:

$$\begin{aligned}
 a_0 &= \frac{1}{L} \int_{-L}^L dx x^2 = \frac{2}{L} \int_0^L dx x^2 = \frac{2}{L} \frac{L^3}{3} = \frac{2L^2}{3} \\
 a_m &= \frac{1}{L} \int_{-L}^L dx x^2 \cos\left(\frac{m\pi x}{L}\right) = \frac{2}{L} \int_0^L dx x^2 \cos\left(\frac{m\pi x}{L}\right) = \frac{2L^2}{m^3\pi^3} [y^2 \sin y + 2y \cos y - 2 \sin y]_0^{m\pi} \\
 &= \frac{2L^2}{m^3\pi^3} \times 2m\pi(-1)^m = \frac{4L^2(-1)^m}{m^2\pi^2}
 \end{aligned} \tag{3.42}$$

For details, see below.

So, overall our Fourier series is

$$f_{\text{FS}}(x) = \frac{L^2}{3} + \frac{4L^2}{\pi^2} \sum_{n=1}^{\infty} \frac{(-1)^n}{n^2} \cos\left(\frac{n\pi x}{L}\right). \tag{3.43}$$

Inside the expansion range $f_{\text{FS}}(x)$ agrees exactly with the original function $f(x)$. *Outside*, however, it does not: $f(x)$ keeps rising quadratically, whereas $f_{\text{FS}}(x)$ repeats with period $2L$. We say the Fourier series has *periodically extended* the function $f(x)$ outside the expansion range. This is shown in Fig. 3.3.

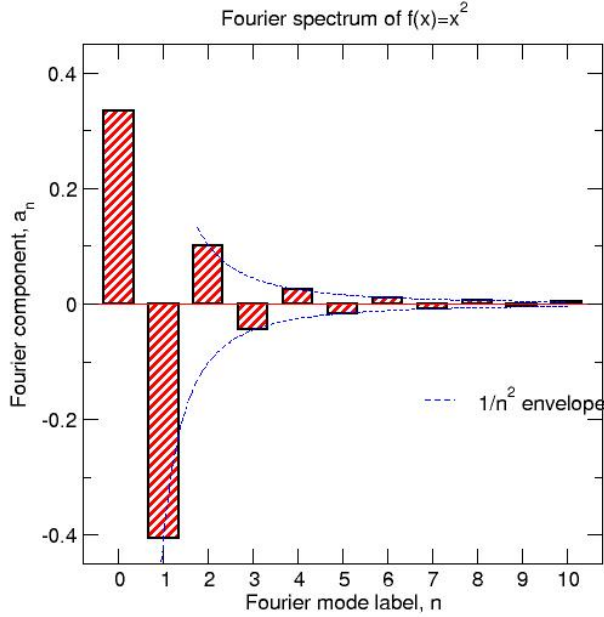

Figure 3.4: The Fourier spectrum a_n (with y -axis in units of L^2) for function $f(x) = x^2$.

There are some special cases where $f_{\text{FS}}(x)$ does agree with $f(x)$ outside the range. If $f(x)$ is itself periodic with period $2L/p$, i.e. the size of the range divided by some integer p s.t. $f(x + 2L/p) = f(x)$, then $f_{\text{FS}}(x)$ will agree with $f(x)$ for all x .

Another special case is where $f(x)$ is only defined in the finite range of expansion e.g. because we are only considering a string extending from 0 to L . Physically, then it does not matter if $f_{\text{FS}}(x)$ deviates from $f(x)$ outside the range.

A plot of the coefficients, $\{c_n\}$ versus n , is known as the *spectrum* of the function: it tells us how much of each frequency is present in the function. The process of obtaining the coefficients is often known as *spectral analysis*. We show the spectrum for $f(x) = x^2$ in Fig. 3.4.

Choice of periodic extension There is no unique way of casting $f(x)$ as a periodic function, and there may be good and bad ways of doing this. For example, suppose we were interested in representing $f(x) = x^2$ for $0 < x < L$: we have already solved this by considering the even function x^2 over $-L < x < L$, so the periodicity can be over a range that is larger than the range of interest. Therefore, we could equally well make an *odd* periodic function by adopting $+x^2$ for $0 < x < L$ and $-x^2$ for $-L < x < 0$. This is then suitable for a sin series. The coefficients for this are

$$\begin{aligned}
 b_m &= \frac{1}{L} \int_0^L dx x^2 \sin\left(\frac{m\pi x}{L}\right) + \frac{1}{L} \int_{-L}^0 dx (-x^2) \sin\left(\frac{m\pi x}{L}\right) \\
 &= \frac{2}{L} \int_0^L dx x^2 \sin\left(\frac{m\pi x}{L}\right) = \frac{2L^2}{m^3\pi^3} [-y^2 \cos y + 2y \sin y + 2 \cos y]_0^{m\pi} \\
 &= \frac{2L^2}{m^3\pi^3} \times [(-1)^{m+1} m^2 \pi^2 + 2(-1)^m - 2]
 \end{aligned} \tag{3.44}$$

So now we have two alternative expansions, both of which represent $f(x) = x^2$ over $0 < x < L$. To

lowest order, these are

$$\cos : f(x) = \frac{L^2}{3} - \frac{4L^2}{\pi^2} \cos\left(\frac{\pi x}{L}\right) + \dots \quad (3.45)$$

$$\sin : f(x) = \frac{2L^2}{\pi} \sin\left(\frac{\pi x}{L}\right) + \dots \quad (3.46)$$

It should be clear that the first of these works better, since the function does behave quadratically near $x = 0$, whereas the single sin term is nothing like the target function. In order to get comparable accuracy, we need many more terms for the sin series than the cos series: the coefficients for the former decline as $1/m^2$, as against only $1/m$ for the latter at large m , showing very poor convergence.

Doing the integrals for the x^2 expansion We need to do the integral

$$a_m = \frac{2}{L} \int_0^L dx x^2 \cos\left(\frac{m\pi x}{L}\right) \quad (3.47)$$

The first stage is to make a substitution that simplifies the argument of the cosine function:

$$y = \frac{m\pi x}{L} \Rightarrow dy = \frac{m\pi}{L} dx \quad (3.48)$$

which also changes the upper integration limit to $m\pi$. So

$$a_m = \frac{2}{L} \int_0^{m\pi} \frac{L}{m\pi} dy \frac{L^2 y^2}{m^2 \pi^2} \cos y = \frac{2L^2}{m^3 \pi^3} \int_0^{m\pi} dy y^2 \cos y. \quad (3.49)$$

We now solve this simplified integral by integrating by parts. An easy way of remembering integration by parts is

$$\int u \frac{dv}{dx} dx = [uv] - \int v \frac{du}{dx} dx \quad (3.50)$$

and in this case we will make $u = y^2$ and $dv/dy = \cos y$. Why? Because we want to differentiate y^2 to make it a simpler function:

$$\int dy y^2 \cos y = y^2 \sin y - \int dy 2y \sin y. \quad (3.51)$$

We now repeat the process for the integral on the RHS, setting $u = 2y$ for the same reason:

$$\int dy y^2 \cos y = y^2 \sin y - \left[-2y \cos y + \int dy 2 \cos y \right] = y^2 \sin y + 2y \cos y - 2 \sin y. \quad (3.52)$$

So, using $\sin m\pi = 0$ and $\cos m\pi = (-1)^m$:

$$a_m = \frac{2L^2}{m^3 \pi^3} [y^2 \sin y + 2y \cos y - 2 \sin y]_0^{m\pi} = \frac{2L^2}{m^3 \pi^3} \times 2m\pi (-1)^m = \frac{4L^2 (-1)^m}{m^2 \pi^2}. \quad (3.53)$$

3.8 Complex Fourier Series

Sines and cosines are one Fourier basis i.e. they provide one way to expand a function in the interval $[-L, L]$. Another, very similar basis is that of complex exponentials.

$$f(x) = \sum_{n=-\infty}^{\infty} c_n \phi_n(x) \quad \text{where} \quad \phi_n(x) = e^{+ik_n x} = e^{in\pi x/L}, \quad (3.54)$$

where $k_n = n\pi/L$ is the *wavenumber*. This is a *complex Fourier series*, because the expansion coefficients, c_n , are in general complex numbers even for a real-valued function $f(x)$. Note that the sum over n runs from $-\infty$ in this case. (The plus sign in phase of the exponentials is a convention chosen to match the convention used for Fourier Transforms in Sec. 4.)

Again, these basis functions are orthogonal. But the orthogonality property only works if we define it to include complex conjugation of $\phi_m(x)$:

$$\int_{-L}^L dx \phi_m(x) \phi_n^*(x) = \int_{-L}^L dx e^{i(k_m - k_n)x} = \left\{ \begin{array}{ll} [x]_{-L}^L & = 2L \quad (\text{if } n = m) \\ \left[\frac{\exp(i(k_m - k_n)x)}{i(k_m - k_n)} \right]_{-L}^L & = 0 \quad (\text{if } n \neq m) \end{array} \right\} = 2L \delta_{mn}. \quad (3.55)$$

For the case $n \neq m$, we note that $m - n$ is a non-zero integer (call it p) and

$$\begin{aligned} \exp[i(k_m - k_n)L] - \exp[i(k_m - k_n)(-L)] &= \exp[ip\pi] - \exp[-ip\pi] \\ &= (\exp[i\pi])^p - (\exp[-i\pi])^p = (-1)^p - (-1)^p = 0. \end{aligned} \quad (3.56)$$

For $p = m - n = 0$ the denominator is also zero, hence the different result. This proves what should be considered an intuitively obvious result: $\exp(i\Delta kx) = \cos(\Delta kx) + i \sin(\Delta kx)$, so both real and imaginary parts oscillate a whole number of times between $x = -L$ and $x = +L$. Thus the whole expression averages to zero unless $\Delta k = 0$.

The orthogonality relation lets us find the coefficients c_m . We multiply both sides by *the complex conjugate of* $\phi_m(x)$ and integrate over the full range:

$$\int_{-L}^L dx \phi_m^*(x) f(x) = \sum_{n=-\infty}^{\infty} c_n \int_{-L}^L dx \phi_m^*(x) \phi_n(x) = \sum_{n=-\infty}^{\infty} c_n 2L \delta_{mn} = c_m 2L \quad (3.57)$$

$$\Rightarrow c_m = \frac{1}{2L} \int_{-L}^L dx \phi_m^*(x) f(x) = \frac{1}{2L} \int_{-L}^L dx e^{-ik_m x} f(x) \quad (3.58)$$

As before, we noted that the integral of a sum is the same as a sum of integrals.

FOURIER ANALYSIS: LECTURE 4

3.8.1 Example

To show the complex Fourier approach in action, we revisit our example of expanding $f(x) = x^2$ for $x \in [-L, L]$. The general expression for the Fourier coefficients, c_m , takes one of the following forms, depending on whether or not m is zero:

$$c_{m=0} = \frac{1}{2L} \int_{-L}^L dx x^2 = \frac{L^2}{3} \quad (3.59)$$

$$c_{m \neq 0} = \frac{1}{2L} \int_{-L}^L dx x^2 e^{-im\pi x/L} = \frac{2L^2(-1)^m}{m^2\pi^2} \quad (3.60)$$

See below for details of how to do the second integral. We notice that in this case all the c_m are real, but this is not the case in general.

ASIDE: doing the integral We want to calculate

$$c_m \equiv \frac{1}{2L} \int_{-L}^L dx x^2 e^{-im\pi x/L} \quad (3.61)$$

To make life easy, we should change variables to make the exponent more simple (whilst keeping y real) i.e. set $y = m\pi x/L$, for which $dy = (m\pi/L) dx$. The integration limits become $\pm m\pi$:

$$c_m = \frac{1}{2L} \int_{-m\pi}^{m\pi} dy \frac{L}{m\pi} \times \frac{L^2 y^2}{m^2 \pi^2} e^{-iy} = \frac{L^2}{2m^3 \pi^3} \int_{-m\pi}^{m\pi} dy y^2 e^{-iy}. \quad (3.62)$$

Now we want to integrate by parts. We want the RHS integral to be simpler than the first, so we set $u = y^2 \Rightarrow du = 2y dy$ and $dv/dy = e^{-iy} \Rightarrow v = e^{-iy}/(-i) = ie^{-iy}$ (multiplying top and bottom by i and recognising $-i \times i = 1$). So

$$c_m = \frac{L^2}{2m^3 \pi^3} \left\{ [iy^2 e^{-iy}]_{-m\pi}^{m\pi} - \int_{-m\pi}^{m\pi} dy 2y \cdot ie^{-iy} \right\} = \frac{L^2}{2m^3 \pi^3} \left\{ [iy^2 e^{-iy}]_{-m\pi}^{m\pi} - 2i \int_{-m\pi}^{m\pi} dy y e^{-iy} \right\} \quad (3.63)$$

The integral is now simpler, so we play the same game again, this time with $u = y \Rightarrow du/dy = 1$ to get:

$$c_m = \frac{L^2}{2m^3 \pi^3} \left\{ [iy^2 e^{-iy}]_{-m\pi}^{m\pi} - 2i \left([iy e^{-iy}]_{-m\pi}^{m\pi} - \int_{-m\pi}^{m\pi} dy ie^{-iy} \right) \right\} \quad (3.64)$$

$$= \frac{L^2}{2m^3 \pi^3} \left\{ [iy^2 e^{-iy}]_{-m\pi}^{m\pi} - 2i \left([iy e^{-iy}]_{-m\pi}^{m\pi} - i [ie^{-iy}]_{-m\pi}^{m\pi} \right) \right\} \quad (3.65)$$

$$= \frac{L^2}{2m^3 \pi^3} [iy^2 e^{-iy} - 2i i y e^{-iy} + 2i i i e^{-iy}]_{-m\pi}^{m\pi} \quad (3.66)$$

$$= \frac{L^2}{2m^3 \pi^3} [e^{-iy} (iy^2 + 2y - 2i)]_{-m\pi}^{m\pi} \quad (3.67)$$

We can now just substitute the limits in, using $e^{im\pi} = e^{-im\pi} = (-1)^m$ (so e^{-iy} has the same value at both limits). Alternatively, we can note that the first and third terms in the round brackets are even under $y \rightarrow -y$ and therefore we will get zero when we evaluate between *symmetric* limits $y = \pm m\pi$ (N.B. this argument only works for symmetric limits). Only the second term, which is odd, contributes:

$$\begin{aligned} c_m &= \frac{L^2}{2m^3\pi^3} [2ye^{-iy}]_{-m\pi}^{m\pi} = \frac{L^2}{2m^3\pi^3} [2m\pi e^{-im\pi} - (-2m\pi)e^{im\pi}] \\ &= \frac{L^2}{2m^3\pi^3} \times 4m\pi(-1)^m = \frac{2L^2(-1)^m}{m^2\pi^2}. \end{aligned} \quad (3.68)$$

3.8.2 Comparing real and complex Fourier expansions

The complex approach may seem an unnecessary complication. Obviously it is needed if we have to represent a complex function, but for real functions we need to go to some trouble in order to make sure that the result is real:

$$f(x) = \sum_{n=-\infty}^{\infty} c_n e^{in\pi x/L} \Rightarrow f(x) = f^*(x) = \sum_{n=-\infty}^{\infty} c_n^* e^{-in\pi x/L} \quad (3.69)$$

Equating the coefficients of the $e^{im\pi x/L}$ mode, we see that the Fourier coefficients have to be *Hermitian*:

$$c_{-m}^* = c_m. \quad (3.70)$$

This shows why it was necessary to consider both positive and negative wavenumbers, unlike in the sin and cos case.

The advantage of the complex approach is that it is often much easier to deal with integrals involving exponentials. We have already seen this when discussing how to prove the orthogonality relations for sin and cos. Also, doing things this way saves having to do twice the work in obtaining coefficients for sin and cos series separately, since both the a_n and b_n coefficients are given by a single integral:

$$c_n = \frac{1}{2L} \int f(x) \exp(-ik_n x) dx = \frac{1}{2L} \int f(x) [\cos k_n x - i \sin k_n x] dx = \frac{1}{2}(a_n - ib_n). \quad (3.71)$$

This extra factor of 1/2 arises from the orthogonality relations, reflecting the fact that the mean value of $|\exp(ikx)|^2$ is 1, whereas the mean of $\cos^2 kx$ or $\sin^2 kx$ is 1/2. Taking the complex conjugate of this relation gives

$$c_n^* = \frac{1}{2}(a_n + ib_n). \quad (3.72)$$

Thus the coefficients for a real series are already known if we know the complex series:

$$a_n = c_n + c_n^*; \quad b_n = i(c_n - c_n^*). \quad (3.73)$$

An alternative (but longer) way of obtaining the same relations is to start by writing cosine and sine as the sum and difference of two complex exponentials:

$$\phi_n(x) = \cos\left(\frac{n\pi x}{L}\right) + i \sin\left(\frac{n\pi x}{L}\right) \Rightarrow \begin{cases} \cos\left(\frac{n\pi x}{L}\right) = \frac{1}{2}[\phi_n(x) + \phi_{-n}(x)] \\ \sin\left(\frac{n\pi x}{L}\right) = \frac{1}{2i}[\phi_n(x) - \phi_{-n}(x)] \end{cases}. \quad (3.74)$$

The last relation is better written as

$$\sin\left(\frac{n\pi x}{L}\right) = \frac{i}{2}[\phi_n^*(x) - \phi_{-n}^*(x)], \quad (3.75)$$

since ϕ^* is involved in the integral for c_n . Note the various pieces of complex manipulation: \sin is real, so nothing changes if we take its conjugate; conjugates multiply, so $(\phi/i)^* = \phi^*(1/i)^* = \phi^*(-i)^* = i\phi^*$. If we now write the integrals for a_n and b_n , we get

$$a_n = c_n + c_{-n}; \quad b_n = i(c_n - c_{-n}), \quad (3.76)$$

which is as before if we recall the Hermitian property of the c_m .

We can check that this works correctly with our example of $f(x) = x^2$. The two sets of coefficients in Eqns. (3.42) and (3.68) were $(a_n, b_n) = (4L^2(-1)^n/n^2\pi^2, 0)$ and $c_n = 2L^2(-1)^n/n^2\pi^2$, so here the reality of c_n forces $b_n = 0$ and $a_n = 2c_n$, as required.

3.9 Differentiating and integrating Fourier series

Once we have a function expressed as a Fourier series, this can be a useful alternative way of carrying out calculus-related operations. This is because differentiation and integration are linear operations that are *distributive* over addition: this means that we can carry out differentiation or integration term-by-term in the series:

$$f(x) = \sum_{n=-\infty}^{\infty} C_n e^{ik_n x} \quad (3.77)$$

$$\Rightarrow \frac{df}{dx} = \sum_{n=-\infty}^{\infty} C_n (ik_n) e^{ik_n x} \quad (3.78)$$

$$\Rightarrow \int f dx = \sum_{n=-\infty}^{\infty} C_n (ik_n)^{-1} e^{ik_n x} + \text{const.} \quad (3.79)$$

The only complication arises in the case of integration, if $C_0 \neq 0$: then the constant term integrates to be $\propto x$, and this needs to be handled separately (it can be expanded in an additional Fourier series).

From these relations, we can see immediately that the Fourier coefficients of a function and its derivative are very simply related by powers of k : if the m^{th} Fourier coefficient of $f(x)$ is C_m , the m^{th} Fourier coefficient of $df(x)/dx$ is $(ik_m)C_m$. The extension to multiple derivatives is obvious: the m^{th} Fourier coefficient of $d^n f(x)/dx^n$ is $(ik_m)^n C_m$.

This approach can be a way to do a difficult integral. Integrals of sines and cosines are relatively easy, so if we need to integrate a function it may be more straightforward to do a Fourier expansion first.

The main caveat with all this is that we still require that all the quantities being considered must be suitable for a Fourier representation, and this may not be so. For example, $f(x) = 1/\sqrt{x}$ for $0 < x < 1$ is an acceptable function: it has a singularity at $x = 0$, but this is integrable, so all the Fourier coefficients converge. But $f'(x) = -x^{-3/2}/2$, which has a divergent integral over $0 < x < 1$. Attempts to use a Fourier representation for $f'(x)$ would come adrift in this case, as is illustrated in Fig. 3.5.

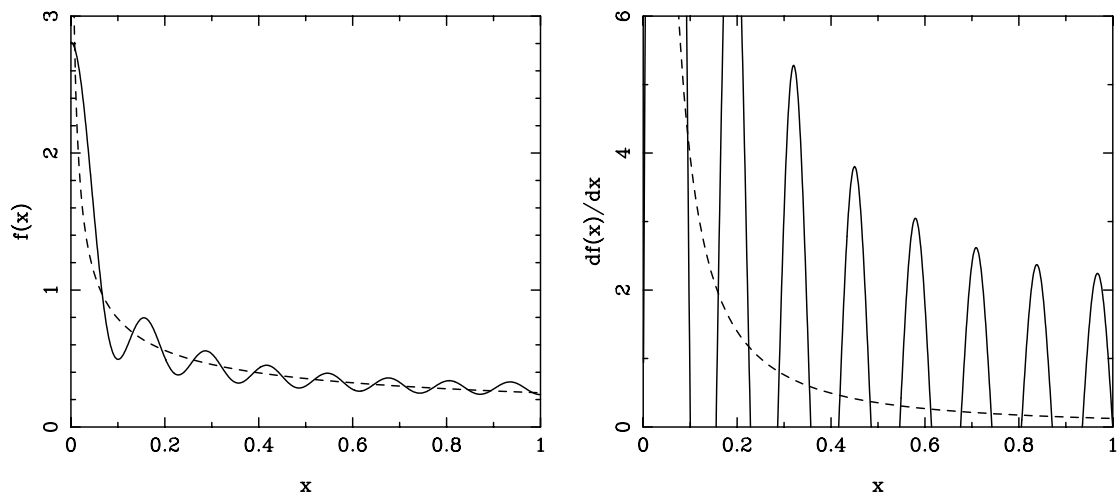

Figure 3.5: The Fourier expansion of the function $f(x) = 1/(4|x|^{1/2})$, $|x| < 1$ is shown in the LH panel (a cosine series, up to $n = 15$). The RH panel compares df/dx with the sum of the derivative of the Fourier series. The mild divergence in f means that the expansion converges; but for df/dx it does not.

3.10 Fourier series and series expansions

We can sometimes exploit Fourier series to either give us series approximations for numerical quantities, or to give us the result of summing a series.

Consider $f(x) = x^2$, which we expanded as a Fourier series in Eqn. (3.43) above, and let's choose the expansion range to be $-\pi \rightarrow \pi$ (i.e. we'll set $L = \pi$). At $x = 0$ we have $f(x) = f_{\text{FS}}(x) = 0$. Substituting into Eqn. (3.43) we have

$$0 = \frac{\pi^2}{3} + \sum_{n=1}^{\infty} \frac{4(-1)^n}{n^2} \quad \Rightarrow \quad \frac{\pi^2}{12} = - \sum_{n=1}^{\infty} \frac{(-1)^n}{n^2} = \sum_{n=1}^{\infty} \frac{(-1)^{n+1}}{n^2} \quad (3.80)$$

This result can be useful in two ways:

1. We solve a physics problem, and find the answer as a sum $\sum_{n=1}^{\infty} \frac{(-1)^{n+1}}{n^2}$. Using the above result we can replace the sum by $\frac{\pi^2}{12}$.
2. We need a numerical approximation for π . We can get this by truncating the sum at some upper value $n = N$ [as in Eqn. (3.87)] and adding together all the terms in the sum.

$$\frac{\pi^2}{12} = 1 - \frac{1}{4} + \frac{1}{9} - \frac{1}{16} + \dots \quad (3.81)$$

Let's call this approximation π_N :

$$\pi_N \equiv \sqrt{12 \sum_{n=1}^N \frac{(-1)^{n+1}}{n^2}} \quad (3.82)$$

Table 1 shows how π_N approaches π as we increase N .

| N | π_N | $\pi_N - \pi$ |
|--------|--------------|---------------|
| 1 | 3.4641016151 | 0.3225089615 |
| 2 | 3.0000000000 | -0.1415926536 |
| 3 | 3.2145502537 | 0.0729576001 |
| 4 | 3.0956959368 | -0.0458967168 |
| 5 | 3.1722757341 | 0.0306830805 |
| 6 | 3.1192947921 | -0.0222978615 |
| 7 | 3.1583061852 | 0.0167135316 |
| 8 | 3.1284817339 | -0.0131109197 |
| 9 | 3.1520701305 | 0.0104774769 |
| 10 | 3.1329771955 | -0.0086154581 |
| 100 | 3.1414981140 | -0.0000945396 |
| 1000 | 3.1415916996 | -0.0000009540 |
| 10000 | 3.1415926440 | -0.0000000095 |
| 100000 | 3.1415926535 | -0.0000000001 |

Table 1: A series approximation to π from Eqn. (3.82)

We can get different series approximations by considering different values of x in the same Fourier series expansions. For instance, consider $x = \pi$. This gives:

$$\pi^2 = \frac{\pi^2}{3} + \sum_{n=1}^{\infty} \frac{4(-1)^n}{n^2} (-1)^n \quad \Rightarrow \quad \frac{\pi^2}{6} = \sum_{n=1}^{\infty} \frac{1}{n^2} \equiv \zeta(2) \quad (3.83)$$

This is an example of the Riemann zeta function $\zeta(s)$ which crops up a lot in physics. It has limits:

$$\zeta(s) \equiv \sum_{n=1}^{\infty} \frac{1}{n^s} \rightarrow \begin{cases} 1 & \text{as } s \rightarrow \infty \\ \infty & \text{as } s \rightarrow 1 \end{cases} \quad (3.84)$$

FOURIER ANALYSIS: LECTURE 5

3.10.1 Convergence of Fourier series

Fourier series (real or complex) are very good ways of approximating functions in a finite range, by which we mean that we can get a good approximation to the function by using only the first few modes (i.e. truncating the sum over n after some low value $n = N$).

This is how music compression works in MP3 players, or how digital images are compressed in JPEG form: we can get a good approximation to the true waveform by using only a limited number of modes, and so all the modes below a certain amplitude are simply ignored.

We saw a related example of this in our approximation to π using Eqn. (3.82) and Table 1.

Not examinable:

Mathematically, this translates as the Fourier components converging to zero i.e. $a_n, b_n \rightarrow 0$ as $n \rightarrow \infty$, provided $f(x)$ is bounded (i.e. has no divergences). But how quickly do the high order coefficients vanish? There are two common cases:

1. The function and its first $p - 1$ derivatives ($f(x), f'(x), \dots, f^{(p-1)}(x)$) are continuous, but the p^{th} derivative $f^{(p)}(x)$ has discontinuities:

$$a_n, b_n \sim 1/n^{p+1} \quad \text{for large } n. \quad (3.85)$$

An example of this was our expansion of $f(x) = x^2$. When we periodically extend the function, there is a discontinuity in the gradient ($p = 1$ derivative) at the boundaries $x = \pm L$. We have already seen $a_n \sim 1/n^2$ as expected (with $b_n = 0$).

2. $f(x)$ is periodic and piecewise continuous (i.e. it has jump discontinuities, but only a finite number within one period):

$$\Rightarrow a_n, b_n \sim 1/n \quad \text{for large } n. \quad (3.86)$$

An example of this is the expansion of the odd function $f(x) = x$, which jumps at the boundary. The Fourier components turn out to be $b_n \sim 1/n$ (with $a_n = 0$).

End of non-examinable section.

3.10.2 How close does it get? Convergence of Fourier expansions

We have seen that the Fourier components generally get smaller as the mode number n increases. If we truncate the Fourier series after N terms, we can define an error D_N that measures how much the truncated Fourier series differs from the original function: i.e. if

$$f_N(x) = \frac{a_0}{2} + \sum_{n=1}^N \left[a_n \cos\left(\frac{n\pi x}{L}\right) + b_n \sin\left(\frac{n\pi x}{L}\right) \right]. \quad (3.87)$$

we define the error as

$$D_N = \int_{-L}^L dx |f(x) - f_N(x)|^2 \geq 0. \quad (3.88)$$

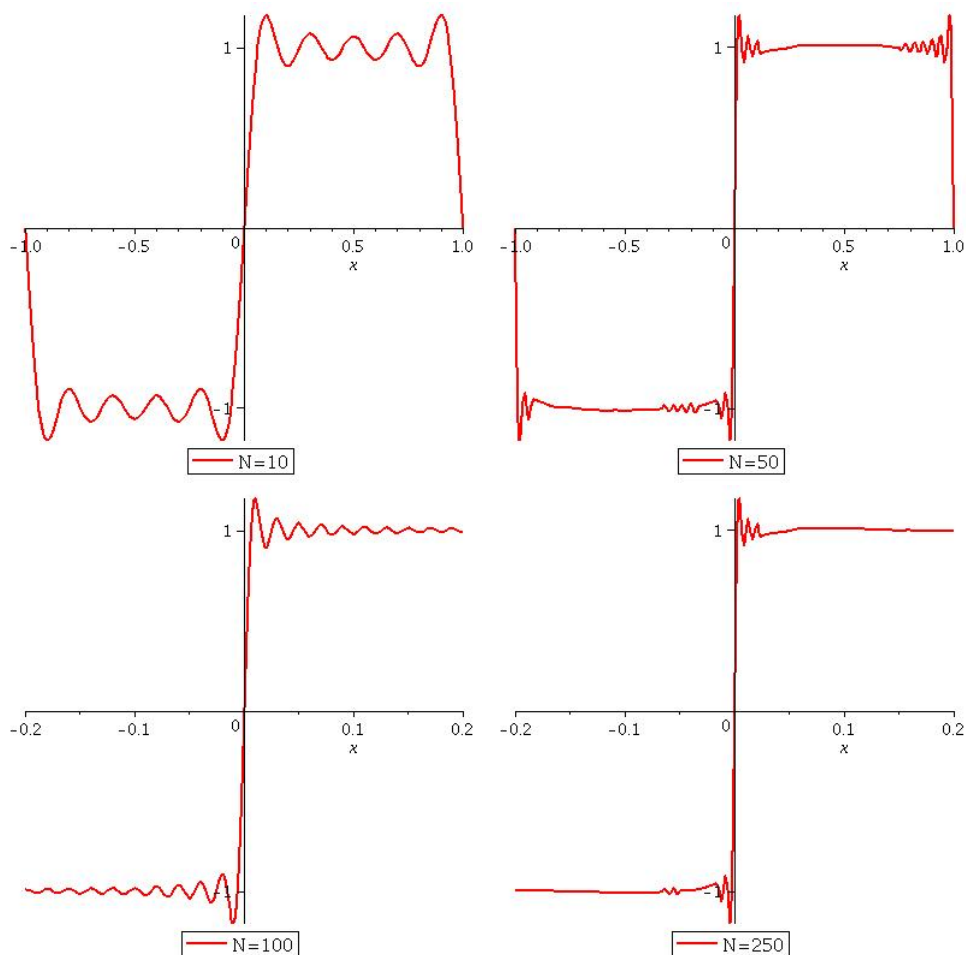

Figure 3.6: The Gibbs phenomenon for truncated Fourier approximations to the signum function Eqn. 3.89. Note the different x -range in the lower two panels.

That is, we square the difference between the original function and the truncated Fourier series at each point x , then integrate across the full range of validity of the Fourier series. Technically, this is what is known as an L^2 norm.

Some things you should know, but which we will not prove: if f is reasonably well-behaved (no non-integrable singularities, and only a finite number of discontinuities), the Fourier series is optimal in the least-squares sense – i.e. if we ask what Fourier coefficients will minimise D_N for some given N , they are exactly the coefficients that we obtain by solving the full Fourier problem.

Furthermore, as $N \rightarrow \infty$, $D_N \rightarrow 0$. This sounds like we are guaranteed that the Fourier series will represent the function exactly in the limit of infinitely many terms. But looking at the equation for D_N , it can be seen that this is not so: it's always possible to have (say) $f_N = 2f$ over some range Δx , and the best we can say is that Δx must tend to zero as N increases.

EXAMPLE: As an example of how Fourier series converge (or not), consider the signum function which picks out the sign of a variable:

$$f(x) = \text{signum } x = \begin{cases} -1 & \text{if } x < 0, \\ +1 & \text{if } x \geq 0, \end{cases} \quad (3.89)$$

| N | D_N |
|-----|--------|
| 10 | 0.0808 |
| 50 | 0.0162 |
| 100 | 0.0061 |
| 250 | 0.0032 |

Table 2: Error D_N on the N -term truncated Fourier series approximation to the signum function Eqn. 3.89.

which we will expand in the range $-1 \leq x \leq 1$ (i.e. we set $L = 1$). The function is odd, so $a_n = 0$ and we find

$$b_n = 2 \int_0^1 dx \sin(n\pi x) = \frac{2}{n\pi} [1 - (-1)^n] . \quad (3.90)$$

$f(x)$ has discontinuities at $x = 0$ and $x = \pm L = \pm 1$ (due to the periodic extension), so from Sec. 3.10.1 we expected $a_n \sim 1/n$.

In Table 2 we show the error D_N for the signum function for increasing values of D_N . As expected the error decreases as N gets larger, but relatively slowly. We'll see why this is in the next section.

3.10.3 Ringing artefacts and the Gibbs phenomenon

We saw above that we can define an error associated with the use of a truncated Fourier series of N terms to describe a function. Note that D_N measures the total error by integrating the deviation at each value of x over the full range. It does not tell us whether the deviations between $f_N(x)$ and $f(x)$ were large and concentrated at certain values of x , or smaller and more evenly distributed over all the full range.

An interesting case is when we try to describe a function with a finite discontinuity (i.e. a jump) using a truncated Fourier series, such as our discussion of the signum function above.

In Fig. 3.6 we plot the original function $f(x)$ and the truncated Fourier series for various N . We find that the truncated sum works well, except near the discontinuity. Here the function overshoots the true value and then has a 'damped oscillation'. As we increase N the oscillating region gets smaller, but the overshoot remains roughly the same size (about 18%).

This overshoot is known as the *Gibbs phenomenon*. Looking at the plot, we can see that it tends to be associated with extended oscillations either side of the step, known as 'ringing artefacts'. Such artefacts will tend to exist whenever we try to describe sharp transitions with Fourier methods, and are one of the reasons that MP3s can sound bad when the compression uses too few modes. We can reduce the effect by using a smoother method of Fourier series summation, but this is well beyond this course. For the interested, there are some more details at http://en.wikipedia.org/wiki/Gibbs_phenomenon.

3.11 Parseval's theorem

There is a useful relationship between the mean square value of the function $f(x)$ and the Fourier coefficients. Parseval's formula is

$$\frac{1}{2L} \int_{-L}^L |f(x)|^2 dx = |a_0/2|^2 + \frac{1}{2} \sum_{n=1}^{\infty} (|a_n|^2 + |b_n|^2) , \quad (3.91)$$

or, for complex Fourier Series,

$$\frac{1}{2L} \int_{-L}^L |f(x)|^2 dx = \sum_{n=-\infty}^{\infty} |c_n|^2. \quad (3.92)$$

The simplicity of the expression in the complex case is an example of the advantage of doing things this way.

The quantity $|c_n|^2$ is known as the *power spectrum*. This is by analogy with electrical circuits, where power is $I^2 R$. So the mean of f^2 is like the average power, and $|c_n|^2$ shows how this is contributed by the different Fourier modes.

Proving Parseval is easier in the complex case, so we will stick to this. The equivalent for the sin+cos series is included for interest, but you are not expected to remember it. First, note that $|f(x)|^2 = f(x)f^*(x)$ and expand f and f^* as complex Fourier Series:

$$|f(x)|^2 = f(x)f^*(x) = \sum_{n=-\infty}^{\infty} c_n \phi_n(x) \sum_m c_m^* \phi_m^*(x) \quad (3.93)$$

(recall that $\phi_n(x) = e^{ik_n x}$). Then we integrate over $-L \leq x \leq L$, noting the orthogonality of ϕ_n and ϕ_m^* :

$$\begin{aligned} \int_{-L}^L |f(x)|^2 dx &= \sum_{m,n=-\infty}^{\infty} c_n c_m^* \int_{-L}^L \phi_n(x) \phi_m^*(x) dx \\ &= \sum_{m,n=-\infty}^{\infty} c_n c_m^* (2L \delta_{mn}) = 2L \sum_{n=-\infty}^{\infty} c_n c_n^* = 2L \sum_{n=-\infty}^{\infty} |c_n|^2 \end{aligned} \quad (3.94)$$

where we have used the orthogonality relation $\int_{-L}^L \phi_n(x) \phi_m^*(x) dx = 2L$ if $m = n$, and zero otherwise.

3.11.1 Summing series via Parseval

Consider once again the case of $f = x^2$. The lhs of Parseval's theorem is $(1/2L) \int_{-L}^L x^4 dx = (1/5)L^4$. The complex coefficients were derived earlier, so the sum on the rhs of Parseval's theorem is

$$\sum_{n=-\infty}^{\infty} |c_n|^2 = |c_0|^2 + \sum_{n \neq 0} |c_n|^2 = \left(\frac{L^2}{3}\right)^2 + 2 \sum_{n=1}^{\infty} \left(\frac{2L^2(-1)^n}{n^2\pi^2}\right)^2 = \frac{L^4}{9} + \sum_{n=1}^{\infty} \frac{8L^4}{n^4\pi^4}. \quad (3.95)$$

Equating the two sides of the theorem, we therefore get

$$\sum_{n=1}^{\infty} \frac{1}{m^4} = (\pi^4/8)(1/5 - 1/9) = \pi^4/90. \quad (3.96)$$

This is a series that converges faster than the ones we obtained directly from the series at special values of x

FOURIER ANALYSIS: LECTURE 6

4 Fourier Transforms

Learning outcomes

In this section you will learn about Fourier transforms: their definition and relation to Fourier series; examples for simple functions; physical examples of their use including the diffraction and the solution of differential equations.

You will learn about the Dirac delta function and the convolution of functions.

4.1 Fourier transforms as a limit of Fourier series

We have seen that a Fourier series uses a complete set of modes to describe functions on a finite interval e.g. the shape of a string of length ℓ . In the notation we have used so far, $\ell = 2L$. In some ways, it is easier to work with ℓ , which we do below; but most textbooks traditionally cover Fourier series over the range $2L$, and these notes follow this trend.

Fourier transforms (FTs) are an extension of Fourier series that can be used to describe nonperiodic functions on an infinite interval. The key idea is to see that a non-periodic function can be viewed as a periodic one, but taking the limit of $\ell \rightarrow \infty$. This is related to our earlier idea of being able to construct a number of different periodic extensions of a given function. This is illustrated in Fig. 4.1 for the case of a square pulse that is only non-zero between $-a < x < +a$. When ℓ becomes large compared to a , the periodic replicas of the pulse are widely separated, and in the limit of $\ell \rightarrow \infty$ we have a single isolated pulse.

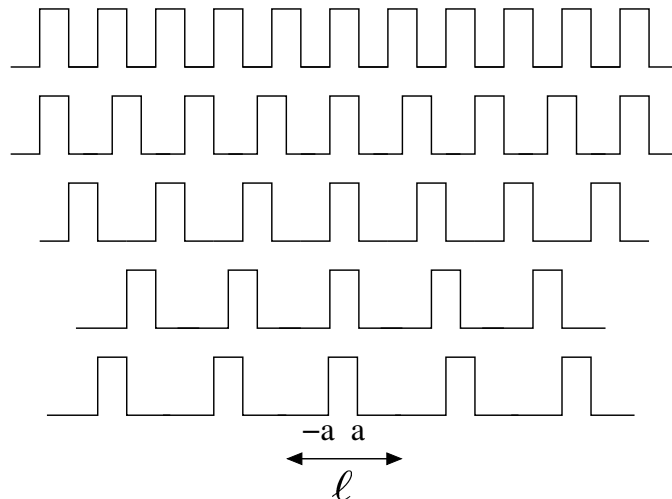

Figure 4.1: Different periodic extensions of a square pulse that is only non-zero between $-a < x < +a$. As the period of the extension, ℓ , increases, the copies of the pulse become more widely separated. In the limit of $\ell \rightarrow \infty$, we have a single isolated pulse and the Fourier series goes over to the Fourier transform.

Fourier series only include modes with wavenumbers $k_n = \frac{2n\pi}{\ell}$ with adjacent modes separated by $\delta k = \frac{2\pi}{\ell}$. What happens to our Fourier series if we let $\ell \rightarrow \infty$? Consider again the complex series for $f(x)$:

$$f(x) = \sum_{n=-\infty}^{\infty} C_n e^{ik_n x}, \quad (4.1)$$

where the coefficients are given by

$$C_n = \frac{1}{\ell} \int_{-\ell/2}^{\ell/2} dx f(x) e^{-ik_n x}. \quad (4.2)$$

and the allowed wavenumbers are $k_n = 2n\pi/\ell$. The separation of adjacent wavenumbers (i.e. for $n \rightarrow n+1$) is $\delta k = 2\pi/\ell$; so as $\ell \rightarrow \infty$, the modes become more and more finely separated in k . In the limit, we are then interested in the variation of C as a function of the continuous variable k . The factor $1/\ell$ outside the integral looks problematic for talking the limit $\ell \rightarrow \infty$, but this can be evaded by defining a new quantity:

$$\tilde{f}(k) \equiv \ell \times C(k) = \int_{-\infty}^{\infty} dx f(x) e^{-ikx}. \quad (4.3)$$

The function $\tilde{f}(k)$ (officially called ‘f tilde’, but more commonly ‘f twiddle’; f_k is another common notation) is the *Fourier transform* of the non-periodic function f .

To complete the story, we need the *inverse Fourier transform*: this gives us back the function $f(x)$ if we know \tilde{f} . Here, we just need to rewrite the Fourier series, remembering the mode spacing $\delta k = 2\pi/\ell$:

$$f(x) = \sum_{k_n} C(k) e^{ikx} = \sum_{k_n} (\ell/2\pi) C(k) e^{ikx} \delta k = \frac{1}{2\pi} \sum_{k_n} \tilde{f}(k) e^{ikx} \delta k. \quad (4.4)$$

In this limit, the final form of the sum becomes an integral over k :

$$\sum g(k) \delta k \rightarrow \int g(k) dk \quad \text{as} \quad \delta k \rightarrow 0; \quad (4.5)$$

this is how integration gets defined in the first place. We can now write an equation for $f(x)$ in which ℓ does not appear:

$$f(x) = \frac{1}{2\pi} \int_{-\infty}^{\infty} dk \tilde{f}(k) e^{ikx}. \quad (4.6)$$

Note the infinite range of integration in k : this was already present in the Fourier series, where the mode number n had no limit.

EXAM TIP: You may be asked to explain how the FT is the limit of a Fourier Series (for perhaps 6 or 7 marks), so make sure you can reproduce the stuff in this section.

The density of states In the above, our sum was over individual Fourier modes. But if $C(k)$ is a continuous function of k , we may as well add modes in bunches over some bin in k , of size Δk :

$$f(x) = \sum_{k \text{ bin}} C(k) e^{ikx} N_{\text{bin}}, \quad (4.7)$$

where N_{bin} is the number of modes in the bin. What is this? It is just Δk divided by the mode spacing, $2\pi/\ell$, so we have

$$f(x) = \frac{\ell}{2\pi} \sum_{k \text{ bin}} C(k) e^{ikx} \Delta k \quad (4.8)$$

The term $\ell/2\pi$ is the *density of states*: it tells us how many modes exist in unit range of k . This is a widely used concept in many areas of physics, especially in thermodynamics. Once again, we can take the limit of $\Delta k \rightarrow 0$ and obtain the integral for the inverse Fourier transform.

Summary A function $f(x)$ and its Fourier transform $\tilde{f}(k)$ are therefore related by:

$$f(x) = \frac{1}{2\pi} \int_{-\infty}^{\infty} dk \tilde{f}(k) e^{ikx}; \quad (4.9)$$

$$\tilde{f}(k) = \int_{-\infty}^{\infty} dx f(x) e^{-ikx}. \quad (4.10)$$

We say that $\tilde{f}(k)$ is the FT of $f(x)$, and that $f(x)$ is the inverse FT of $\tilde{f}(k)$.

EXAM TIP: If you are asked to state the relation between a function and its Fourier transform (for maybe 3 or 4 marks), it is sufficient to quote these two equations. If the full derivation is required, the question will ask explicitly for it.

Note that, since the Fourier Transform is a *linear* operation,

$$FT[f(x) + g(x)] = \tilde{f}(k) + \tilde{g}(k). \quad (4.11)$$

For a real function $f(x)$, its FT satisfies the same Hermitian relation that we saw in the case of Fourier series:

$$\tilde{f}(-k) = \tilde{f}^*(k) \quad (4.12)$$

Exercise: prove this.

FT conventions Eqns. (4.10) and (4.9) are the definitions we will use for FTs throughout this course. Unfortunately, there are many different conventions in active use for FTs. Aside from using different symbols, these can differ in:

- The sign in the exponent
- The placing of the 2π prefactor(s) (and sometimes it is $\sqrt{2\pi}$)
- Whether there is a factor of 2π in the exponent

The bad news is that you will probably come across all of these different conventions. The good news is that it is relatively easy to convert between them if you need to. The best news is that you will almost never need to do this conversion.

k space and momentum space The Fourier convention presented here is the natural one that emerges as the limit of the Fourier series. But it has the disadvantage that it treats the Fourier transform and the inverse Fourier transform differently by a factor of 2π , whereas in physics we need to learn to treat the functions $f(x)$ and $\tilde{f}(k)$ as equally valid forms of the same thing: the ‘real-space’ and ‘k-space’ forms. This is most obvious in quantum mechanics, where a wave function $\exp(ikx)$ represents a particle with a well-defined momentum, $p = \hbar k$ according to de Broglie’s hypothesis. Thus the description of a function in terms of $\tilde{f}(k)$ is often called the ‘momentum-space’ version.

The result that illustrates this even-handed approach most clearly is to realise that the Fourier transform of $f(x)$ can itself be transformed:

$$\widetilde{\tilde{f}(k)}(K) = \int_{-\infty}^{\infty} dk \tilde{f}(k) e^{-iKk}. \quad (4.13)$$

We will show below that

$$\widetilde{\tilde{f}(k)}(K) = 2\pi f(-K) : \quad (4.14)$$

so in essence, repeating the Fourier transform gets you back the function you started with. f and \tilde{f} are really just two sides of the same coin.

FOURIER ANALYSIS: LECTURE 7

4.2 Some simple examples of FTs

In this section we’ll find the FTs of some simple functions.

EXAM TIP: You may be asked to define and sketch $f(x)$ in each case, and also to calculate and sketch $\tilde{f}(k)$.

4.2.1 The top-hat

A top-hat function $\Pi(x)$ of height h and width $2a$ (a assumed positive), centred at $x = d$ is defined by:

$$\Pi(x) = \begin{cases} h, & \text{if } d - a < x < d + a, \\ 0, & \text{otherwise.} \end{cases} \quad (4.15)$$

The function is sketched in Fig. 4.2.

Its FT is:

$$\tilde{f}(k) = \int_{-\infty}^{\infty} dx \Pi(x) e^{-ikx} = h \int_{d-a}^{d+a} dx e^{-ikx} = 2ah e^{-ikd} \text{sinc}(ka) \quad (4.16)$$

The derivation is given below. The function $\text{sinc } x \equiv \frac{\sin x}{x}$ is sketched in Fig. 4.3 (with notes on how to do this also given below). $\tilde{f}(k)$ will look the same (for $d = 0$), but the nodes will now be at $k = \pm \frac{n\pi}{a}$ and the intercept will be $2ah$ rather than 1. You are very unlikely to have to sketch $\tilde{f}(k)$ for $d \neq 0$.

EXAM TIPS: If the question sets $d = 0$, clearly there is no need to do a variable change from x to y .

Sometimes the question specifies that the top-hat should have unit area i.e. $h \times (2a) = 1$, so you can replace h .

The width of the top-hat won't necessarily be $2a$...

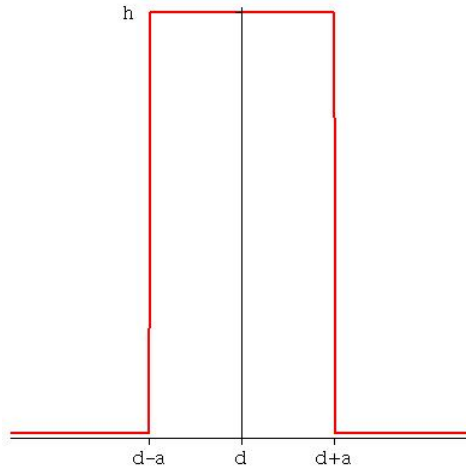

Figure 4.2: Sketch of top-hat function defined in Eqn. (4.15)

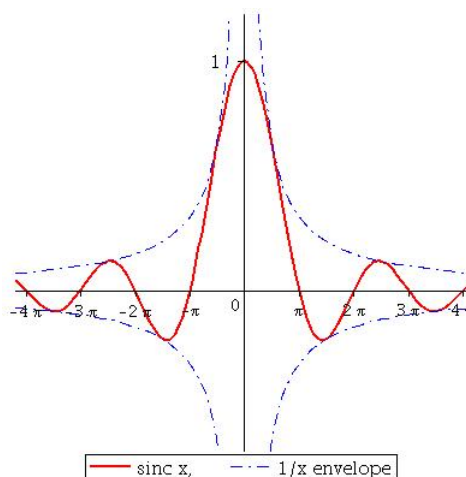

Figure 4.3: Sketch of $\text{sinc } x \equiv \frac{\sin x}{x}$

Deriving the FT:

$$\tilde{f}(k) = \int_{-\infty}^{\infty} dx \Pi(x) e^{-ikx} = h \int_{d-a}^{d+a} dx e^{-ikx} \quad (4.17)$$

Now we make a substitution $u = x - d$ (which now centres the top-hat at $u = 0$). The integrand e^{-ikx} becomes $e^{-ik(u+d)} = e^{-iku} \times e^{-ikd}$. We can pull the factor e^{-ikd} outside the integral because it does not depend on u . The integration limits become $u = \pm a$. There is no scale factor, i.e. $du = dx$.

This gives

$$\begin{aligned}\tilde{f}(k) &= he^{-ikd} \int_{-a}^a du e^{-iku} = he^{-ikd} \left[\frac{e^{-iku}}{-ik} \right]_{-a}^a = he^{-ikd} \left(\frac{e^{-ika} - e^{ika}}{-ik} \right) \\ &= he^{-ikd} \times \frac{2a}{ka} \times \frac{e^{ika} - e^{-ika}}{2i} = 2ah e^{-ikd} \times \frac{\sin(ka)}{ka} = 2ah e^{-ikd} \operatorname{sinc}(ka)\end{aligned}\quad (4.18)$$

Note that we conveniently multiplied top and bottom by $2a$ midway through.

Sketching sinc x : You should think of $\operatorname{sinc} x \equiv \frac{\sin x}{x}$ as a $\sin x$ oscillation (with nodes at $x = \pm n\pi$ for integer n), but with the amplitude of the oscillations dying off as $1/x$. Note that $\operatorname{sinc} x$ is an even function, so it is symmetric when we reflect about the y -axis.

The only complication is at $x = 0$, when $\operatorname{sinc} 0 = \frac{0}{0}$ which appears undefined. To deal with this, expand $\sin x = x - x^3/3! + x^5/5! + \dots$, so it is obvious that $\sin x/x \rightarrow 1$ as $x \rightarrow 0$.

EXAM TIP: Make sure you can sketch this, and that you label all the zeros ('nodes') and intercepts.

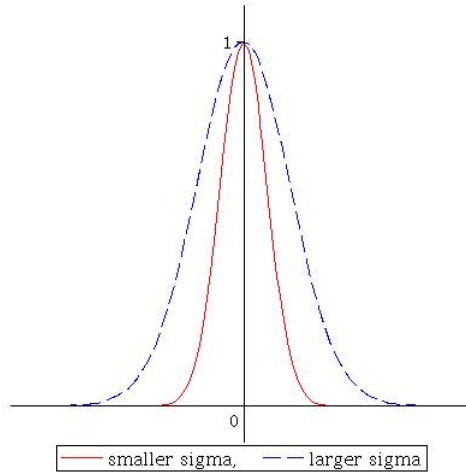

Figure 4.4: Sketch of Gaussians with $N = 1$

4.2.2 The Gaussian

The Gaussian curve is also known as the bell-shaped or normal curve. A Gaussian of width σ centred at $x = d$ is defined by:

$$f(x) = N \exp\left(-\frac{(x-d)^2}{2\sigma^2}\right) \quad (4.19)$$

where N is a normalization constant, which is often set to 1. We can instead define the *normalized* Gaussian, where we choose N so that the area under the curve to be unity i.e. $N = 1/\sqrt{2\pi\sigma^2}$. This normalization can be proved by a neat trick, which is to extend to a two-dimensional Gaussian for two independent (zero-mean) variables x and y , by multiplying the two independent Gaussian functions:

$$p(x, y) = \frac{1}{2\pi\sigma^2} e^{-(x^2+y^2)/2\sigma^2}. \quad (4.20)$$

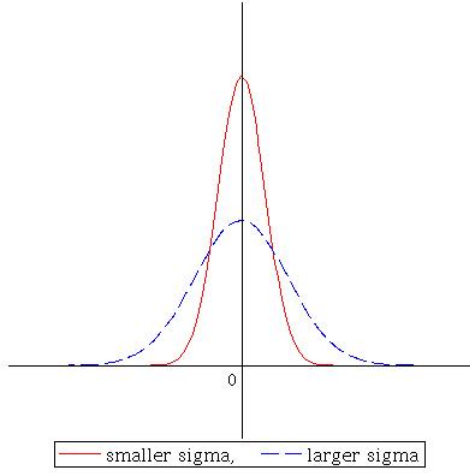

Figure 4.5: Sketch of normalized Gaussians. The intercepts are $f(0) = \frac{1}{\sqrt{2\pi\sigma^2}}$.

The integral over both variables can now be rewritten using polar coordinates:

$$\iint p(x, y) dx dy = \int p(x, y) 2\pi r dr = \frac{1}{2\pi\sigma^2} \int 2\pi r e^{-r^2/2\sigma^2} dr \quad (4.21)$$

and the final expression clearly integrates to

$$P(r > R) = \exp(-R^2/2\sigma^2), \quad (4.22)$$

so the distribution is indeed correctly normalized.

The Gaussian is sketched for $d = 0$ and two different values of the width parameter σ . Fig. 4.4 has $N = 1$ in each case, whereas Fig. 4.5 shows normalized curves.

For $d = 0$, the FT of the Gaussian is

$$\tilde{f}(k) = \int_{-\infty}^{\infty} dx N \exp\left(-\frac{x^2}{2\sigma^2}\right) e^{-ikx} = \sqrt{2\pi} N \sigma \exp\left(-\frac{k^2\sigma^2}{2}\right), \quad (4.23)$$

i.e. the FT of a Gaussian is another Gaussian (this time as a function of k).

Deriving the FT For notational convenience, let's write $a = \frac{1}{2\sigma^2}$, so

$$\tilde{f}(k) = N \int_{-\infty}^{\infty} dx \exp(-[ax^2 + ikx]) \quad (4.24)$$

Now we can complete the square inside [...]:

$$-ax^2 - ikx = -a\left(x + \frac{ik}{2a}\right)^2 - \frac{k^2}{4a} \quad (4.25)$$

giving

$$\tilde{f}(k) = Ne^{-k^2/4a} \int_{-\infty}^{\infty} dx \exp\left(-a\left[x + \frac{ik}{2a}\right]^2\right). \quad (4.26)$$

We then make a change of variables:

$$u = \sqrt{a}\left(x + \frac{ik}{2a}\right). \quad (4.27)$$

This does not change the limits on the integral, and the scale factor is $dx = du/\sqrt{a}$, giving

$$\tilde{f}(k) = \frac{N}{\sqrt{a}} e^{-k^2/4a} \int_{-\infty}^{\infty} du e^{-u^2} = N \sqrt{\frac{\pi}{a}} \times e^{-k^2/4a} = e^{-k^2/4a} . \quad (4.28)$$

where we changed back from a to σ . To get this result, we have used the standard result

$$\int_{-\infty}^{\infty} du e^{-u^2} = \sqrt{\pi} . \quad (4.29)$$

This looks plausible at a quick glance, but you should feel a little uneasy, since the variable u is not real and the integral is along a line in the complex plane that is displaced from the x axis. At the level of this course, it's not possible to prove that this makes no difference to the result.

4.3 Reciprocal relations between a function and its FT

These examples illustrate a general *and very important* property of FTs: there is a reciprocal (i.e. inverse) relationship between the width of a function and the width of its Fourier transform. That is, narrow functions have wide FTs and wide functions have narrow FTs.

This important property goes by various names in various physical contexts, e.g.:

- Heisenberg Uncertainty Principle: the rms uncertainty in position space (Δx) and the rms uncertainty in momentum space (Δp) are inversely related: $(\Delta x)(\Delta p) \geq \hbar/2$. The equality holds for the Gaussian case (see below).
- Bandwidth theorem: to create a very short-lived pulse (small Δt), you need to include a very wide range of frequencies (large $\Delta \omega$).
- In optics, this means that big objects (big relative to wavelength of light) cast sharp shadows (narrow FT implies closely spaced maxima and minima in the interference fringes).

We discuss two explicit examples in the following subsections:

4.3.1 The top-hat

The width of the top-hat as defined in Eqn. (4.15) is obviously $2a$.

For the FT, whilst the sinc ka function extends across all k , it dies away in amplitude, so it does have a width. Exactly how we define the width does not matter; let's say it is the distance between the first nodes $k = \pm\pi/a$ in each direction, giving a width of $2\pi/a$.

Thus the width of the function is proportional to a , and the width of the FT is proportional to $1/a$. Note that this will be true for any reasonable definition of the width of the FT.

4.3.2 The Gaussian

Again, the Gaussian extends infinitely but dies away, so we can define a width. For a Gaussian, it is easy to do this rigorously in terms of the standard deviation (square root of the average of $(x - d)^2$), which is just σ (check you can prove this).

Comparing the form of FT in Eqn. (4.23) to the original definition of the Gaussian in Eqn. (4.19), if the width of $f(x)$ is σ , the width of $\tilde{f}(k)$ is $1/\sigma$ by the same definition. Again, we have a reciprocal relationship between the width of the function and that of its FT. Since $p = \hbar k$, the width in momentum space is \hbar times that in k space.

The only subtlety in relating this to the uncertainty principle is that the probability distributions use $|\psi|^2$, not $|\psi|$. If the width of $\psi(x)$ is σ , then the width of $|\psi|^2$ is $\sigma/\sqrt{2}$. Similarly, the uncertainty in momentum is $(1/\sigma)/\sqrt{2}$, which gives the extra factor 1/2 in $(\Delta x)(\Delta p) = \hbar/2$.

4.4 Fourier transforms and diffraction

The mathematics of Fourier analysis lies at the heart of diffraction. Suppose we shine coherent light in the form of a single plane wave onto an optical grating that allows light through with a variable transmission. We can describe this using a *transmission function* $t(x)$ whose values are positive or zero. A single slit of finite width therefore has a top-hat transmission function $t(x) = \Pi(x)$, where x measures the distance across the grating (perpendicular to the direction of the incident radiation). The far-field diffraction pattern for light passing through this grating is related to the FT of the transmission function. To see this,

- Using Huygens' principle, each point on the grating x is a source of secondary, spherical wavelets.
- The amplitude of the electric field associated with each set of spherical wavelets $E(x) \propto t(x)$.
- Place a detector a long way away (relative to the size of the grating), so that all light reaching it effectively left the grating at the same angle θ to the normal. This is the *far-field* limit, otherwise known as Fraunhofer diffraction.
- The observed electric field $E(\theta)$ is given by summing the contributions from each position on the grating x , allowing for the path difference $\delta x = x \sin \theta$ (relative to the arbitrary, but fixed, choice of origin). The wavelet from position x contributes

$$E(x) \propto t(x) \exp \left[-i \frac{2\pi}{\lambda} (\delta x) \right] = t(x) \exp \left[-i \frac{2\pi}{\lambda} x \sin \theta \right] .$$

- Because the light is coherent, the total observed electrical field is

$$E(\theta) \propto \int_{-\infty}^{\infty} dx E(x) \propto \int_{-\infty}^{\infty} dx t(x) \exp \left[-i \frac{2\pi}{\lambda} x \sin \theta \right] .$$

- Writing $v = (2\pi/\lambda) \sin \theta$, we have

$$E(\theta) \propto \int_{-\infty}^{\infty} dx t(x) e^{-ivx} ;$$

- i.e the electric field is (proportional to) the Fourier transform of the transmission function (using v as the FT variable rather than k).
- The observed intensity is $I(\theta) \propto |E(\theta)|^2$.

FOURIER ANALYSIS: LECTURE 8

5 The Dirac delta function

We have already given a brief introduction to the delta function, and now we should revisit it more thoroughly. The Dirac delta function is a very useful tool in physics, as it can be used to represent a very localised or instantaneous *impulse*, of which the outstanding example is a point charge or point mass.

5.1 Definition

Recall that the delta function $\delta(x - d)$ is defined by *two* expressions. First, it is zero everywhere except at the point $x = d$ where it is infinite:

$$\delta(x - d) = \begin{cases} 0 & \text{for } x \neq d, \\ \rightarrow \infty & \text{for } x = d. \end{cases} \quad (5.30)$$

Secondly, it tends to infinity at $x = d$ in such a way that the area under the Dirac delta function is unity:

$$\int_{-\infty}^{\infty} dx \delta(x - d) = 1. \quad (5.31)$$

We have also seen how the function can be represented in practice as the limit of a finite function whose width tends to zero. We illustrated this by the top-hat function, but it is important to be clear that this is a matter of convenience: for example, we might just as easily have used a normalized Gaussian.

EXAM TIP: When asked to define the Dirac delta function, make sure you write *both* Eqns. (5.30) and (5.31). These are the only general definitions of the function, and should not be confused with a specific representation such as the limit of a top-hat.

5.1.1 Delta function of a more complicated argument

Sometimes you may come across the Dirac delta function of a more complicated argument, $\delta[f(x)]$, e.g. $\delta(x^2 - 4)$. How do we deal with these? Essentially we use the definition that the delta function integrates to unity when it is integrated with respect to its argument. i.e.

$$\int_{-\infty}^{\infty} \delta[f(x)] df = 1. \quad (5.32)$$

Changing variables from f to x ,

$$\int \delta[f(x)] \left| \frac{df}{dx} \right| dx = 1, \quad (5.33)$$

where we have not put the limits on x , as they depend on $f(x)$. Note the modulus sign around df/dx : this is the 1D version of the Jacobian determinant in change of variables. If we had simply used the chain rule and written df/dx instead, there is no guarantee that the integral would be over increasing values of x . Now, $\delta[f(x)]$ can only produce a spike at the point $x = x_0$ where $f(x_0) = 0$, so it must be proportional to $\delta(x - x_0)$. The constant of proportionality comes from requiring the integral to be unity:

$$\delta[f(x)] = \frac{\delta(x - x_0)}{|df/dx|_{x=x_0}}, \quad (5.34)$$

where the derivative is evaluated at the point $x = x_0$. Note that if there is more than one solution ($x_i; i = 1, \dots$) to $f = 0$, then $\delta(f)$ is a sum

$$\delta[f(x)] = \sum_i \frac{\delta(x - x_i)}{|df/dx|_{x=x_i}}. \quad (5.35)$$

5.1.2 Some other properties of the delta function

The proofs of the following results are left as exercises:

$$\begin{aligned} \delta(-x) &= \delta(x) \\ x\delta(x) &= 0 \\ \delta(ax) &= \frac{\delta(x)}{|a|} \\ \delta(x^2 - a^2) &= \frac{\delta(x - a) + \delta(x + a)}{2|a|}. \end{aligned} \quad (5.36)$$

5.2 Sifting property

The *sifting property* of the Dirac delta function is that, given some function $f(x)$:

$$\int_{-\infty}^{\infty} dx \delta(x - d) f(x) = f(d) \quad (5.37)$$

i.e. the delta function picks out the value of the function at the position of the spike (so long as it is within the integration range). This is just like the sifting property of the Kronecker delta inside a discrete sum.

EXAM TIP: If you are asked to state the sifting property, it is sufficient to write Eqn. (5.37). You do not need to prove the result as below unless specifically asked to.

Technical aside: The integration limits don't technically need to be infinite in the above formulæ. If we integrate over a finite range $a < x < b$ the expressions become:

$$\int_a^b dx \delta(x - d) = \begin{cases} 1 & \text{for } a < d < b, \\ 0 & \text{otherwise.} \end{cases} \quad (5.38)$$

$$\int_a^b dx \delta(x - d) f(x) = \begin{cases} f(d) & \text{for } a < d < b, \\ 0 & \text{otherwise.} \end{cases} \quad (5.39)$$

That is, we get the above results if the position of the spike is inside the integration range, and zero otherwise.

We can use the representation of the Dirac delta function as the limit of a top-hat to prove the sifting property given in Eqn. (5.37):

$$\int_{-\infty}^{\infty} dx f(x) \delta(x) = \int_{-\infty}^{\infty} dx f(x) \lim_{a \rightarrow 0} \Pi_a(x) = \lim_{a \rightarrow 0} \int_{-\infty}^{\infty} dx f(x) \Pi_a(x). \quad (5.40)$$

We are free to pull the limit outside the integral because nothing else depends on a . Substituting for $\Pi_a(x)$, the integral is only non-zero between $-a$ and a . Similarly, we can pull the normalization factor out to the front:

$$\int_{-\infty}^{\infty} dx f(x) \delta(x) = \lim_{a \rightarrow 0} \frac{1}{2a} \int_{-a}^a dx f(x). \quad (5.41)$$

What this is doing is averaging f over a narrow range of width $2a$ around $x = 0$. Provided the function is *continuous*, this will converge to a well-defined value $f(0)$ as $a \rightarrow 0$ (this is pretty well the definition of continuity).

Alternatively, suppose the function was differentiable at $x = 0$ (which not all continuous functions will be: e.g. $f(x) = |x|$). Then we can Taylor expand the function around $x = 0$ (i.e. the position of the centre of the spike):

$$\int_{-\infty}^{\infty} dx f(x) \delta(x) = \lim_{a \rightarrow 0} \frac{1}{2a} \int_{-a}^a dx \left[f(0) + x f'(0) + \frac{x^2}{2!} f''(0) + \dots \right]. \quad (5.42)$$

The advantage of this is that all the $f^{(n)}(0)$ are constants, which makes the integral easy:

$$\int_{-\infty}^{\infty} dx f(x) \delta(x) = \lim_{a \rightarrow 0} \frac{1}{2a} \left(f(0) [x]_{-a}^a + f'(0) \left[\frac{x^2}{2} \right]_{-a}^a + \frac{f''(0)}{2!} \left[\frac{x^3}{3} \right]_{-a}^a + \dots \right) \quad (5.43)$$

$$= \lim_{a \rightarrow 0} \left(f(0) + \frac{a^2}{6} f''(0) + \dots \right) = f(0). \quad (5.44)$$

Note that the odd terms vanished after integration. This is special to the case of the spike being centred at $x = 0$. It is a useful exercise to see what happens if the spike is centred at $x = d$ instead.

EXAM TIP: An exam question may ask you to derive the sifting property in this way. Make sure you can do it.

5.3 Calculus with the delta function

The δ -function is easily integrated:

$$\int_{-\infty}^x dy \delta(y - d) = \Theta(x - d), \quad (5.45)$$

where

$$\Theta(x - d) = \begin{cases} 0 & x < d \\ 1 & x \geq d \end{cases} \quad (5.46)$$

which is called the *Heaviside function*, or just the ‘step function’.

The derivative can also be written down, realising that the delta-function must obey the relation $f(x)\delta(x) = f(0)\delta(x)$, and applying the product rule:

$$f(x) d\delta(x)/dx = -f'(x) \delta(x) + f(0) d\delta(x)/dx. \quad (5.47)$$

Integrating this over an infinite range, the first term on the RHS gives $-f'(0)$, using the sifting property; the second term gives zero, since $\delta(x) = 0$ at either end of the interval. Thus the derivative of the delta-function sifts for (minus) the derivative of the function:

$$\int_{-\infty}^{\infty} f(x) [d\delta(x)/dx] dx = -f'(0), \quad (5.48)$$

which could alternatively be proved by applying integration by parts.

5.4 More than one dimension

In some physical situations (e.g. a point charge at $\mathbf{r} = \mathbf{r}_0$), we might need a 3D Dirac delta function, which we can write as a product of three 1D delta functions:

$$\delta(\mathbf{r} - \mathbf{r}_0) = \delta(x - x_0)\delta(y - y_0)\delta(z - z_0) \quad (5.49)$$

where $\mathbf{r}_0 = (x_0, y_0, z_0)$. Note that $\delta(\mathbf{r} - \mathbf{a})$ is not the same as $\delta(r - a)$: the former picks out a point at position \mathbf{a} , but the latter picks out an annulus of radius a . Suppose we had a spherically symmetric function $f(r)$. The sifting property of the 3D function is

$$\int f(\mathbf{r}) \delta(\mathbf{r} - \mathbf{a}) d^3x = f(\mathbf{a}) = f(a), \quad (5.50)$$

whereas

$$\int f(\mathbf{r}) \delta(r - a) d^3x = \int f(r) \delta(r - a) 4\pi r^2 dr = 4\pi a^2 f(a). \quad (5.51)$$

5.5 Physical importance of the delta function

The δ -function is a tool that arises a great deal in physics. There are a number of reasons for this. One is that the classical world is made up out of discrete particles, even though we often treat matter as having continuously varying properties such as density. Individual particles of zero size have infinite density, and so are perfectly suited to be described by δ -functions. We can therefore write the density field produced by a set of particles at positions \mathbf{x}_i as

$$\rho(\mathbf{x}) = \sum_i M_i \delta(\mathbf{x} - \mathbf{x}_i). \quad (5.52)$$

This expression means we can treat all matter in terms of just the density as a function of position, whether the matter is continuous or made of particles.

This decomposition makes us look in a new way at the sifting theorem:

$$f(x) = \int f(q) \delta(x - q) dq. \quad (5.53)$$

The integral is the limit of a sum, so this actually says that the function $f(x)$ can be thought of as made up by adding together infinitely many δ -function spikes: think of a function as a mathematical hedgehog. This turns out to be an incredibly useful viewpoint when solving linear differential equations: the response of a given system to an applied force f can be calculated if we know how the system responds to a single spike. This response is called a *Green's function*, and will be a major topic later in the course.

5.6 FT and integral representation of $\delta(x)$

The Dirac delta function is very useful when we are doing FTs. The FT of the delta function follows easily from the sifting property:

$$\tilde{f}(k) = \int_{-\infty}^{\infty} dx \delta(x-d) e^{-ikx} = e^{-ikd}. \quad (5.54)$$

In the special case $d = 0$, we get simply $\tilde{f}(k) = 1$.

The inverse FT gives us the *integral representation* of the delta function:

$$\delta(x-d) = \frac{1}{2\pi} \int_{-\infty}^{\infty} dk \tilde{f}(k) e^{ikx} = \frac{1}{2\pi} \int_{-\infty}^{\infty} dk e^{-ikd} e^{ikx} \quad (5.55)$$

$$= \frac{1}{2\pi} \int_{-\infty}^{\infty} dk e^{ik(x-d)}. \quad (5.56)$$

You ought to worry that it's entirely unobvious whether this integral converges, since the integrand doesn't die off at ∞ . A safer approach is to define the δ -function (say) in terms of a Gaussian of width σ , where we know that the FT and inverse FT are well defined. Then we can take the limit of $\sigma \rightarrow 0$.

In the same way that we have defined a delta function in x , we can also define a delta function in k . This would, for instance, represent a signal composed of oscillations of a single frequency or wavenumber K . Again, we can write it in integral form if we wish:

$$\delta(k-K) = \frac{1}{2\pi} \int_{-\infty}^{\infty} e^{i(k-K)x} dx. \quad (5.57)$$

This k -space delta function has exactly the same sifting properties when we integrate over k as the original version did when integrating over x .

Note that the sign of the exponent is irrelevant:

$$\delta(x) = \frac{1}{2\pi} \int_{-\infty}^{\infty} e^{\pm ikx} dk, \quad (5.58)$$

which is proved by changing variable from k to $-k$ (the limits swap, which cancels the minus sign arising from $dk \rightarrow -dk$).

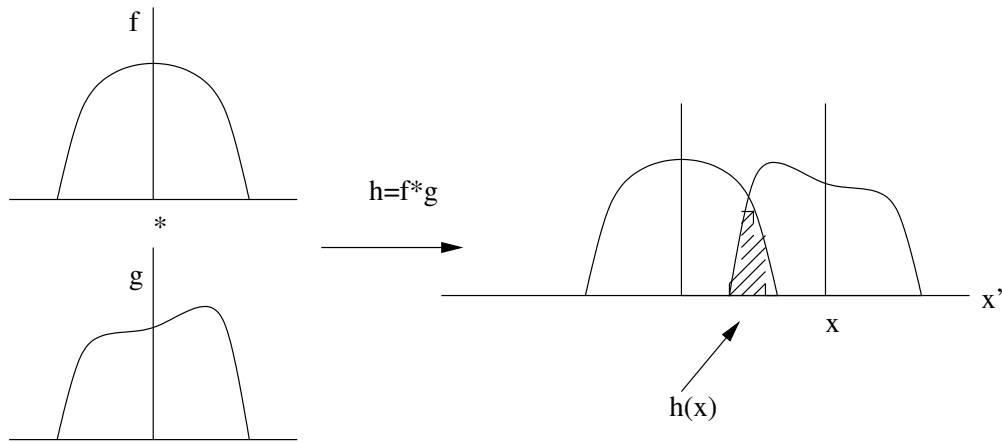

Figure 6.6: Illustration of the convolution of two functions, viewed as the area of the overlap resulting from a relative shift of x .

FOURIER ANALYSIS: LECTURE 9

6 Convolution

Convolution combines two (or more) functions in a way that is useful for describing physical systems. Convolution describes, for example, how optical systems respond to an image: it gives a mathematical description of the process of blurring. We will also see how Fourier solutions to differential equations can often be expressed as a convolution. The FT of the convolution is easy to calculate, so Fourier methods are ideally suited for solving problems that involve convolution.

First, the definition. The convolution of two functions $f(x)$ and $g(x)$ is defined to be

$$f(x) * g(x) = \int_{-\infty}^{\infty} dx' f(x')g(x - x') , \quad (6.59)$$

The result is also a function of x , meaning that we get a different number for the convolution for each possible x value. Note the positions of the dummy variable x' , especially that the argument of g is $x - x'$ and not $x' - x$ (a common mistake in exams).

There are a number of ways of viewing the process of convolution. Most directly, the definition here is a measure of *overlap*: the functions f and g are shifted relative to one another by a distance x , and we integrate to find the product. This viewpoint is illustrated in Fig. 6.6.

But this is not the best way of thinking about convolution. The real significance of the operation is that it represents a *blurring* of a function. Here, it may be helpful to think of $f(x)$ as a signal, and $g(x)$ as a blurring function. As written, the integral definition of convolution instructs us to take the signal at x' , $f(x')$, and replace it by something proportional to $f(x')g(x - x')$: i.e. spread out over a range of x around x' . This turns a sharp feature in the signal into something fuzzy centred at the same location. This is exactly what is achieved e.g. by an out-of-focus camera.

Alternatively, we can think about convolution as a form of averaging. Take the above definition of convolution and put $y = x - x'$. Inside the integral, x is constant, so $dy = -dx'$. But now we are integrating from $y = \infty$ to $-\infty$, so we can lose the minus sign by re-inverting the limits:

$$f(x) * g(x) = \int_{-\infty}^{\infty} dy f(x - y)g(y) . \quad (6.60)$$

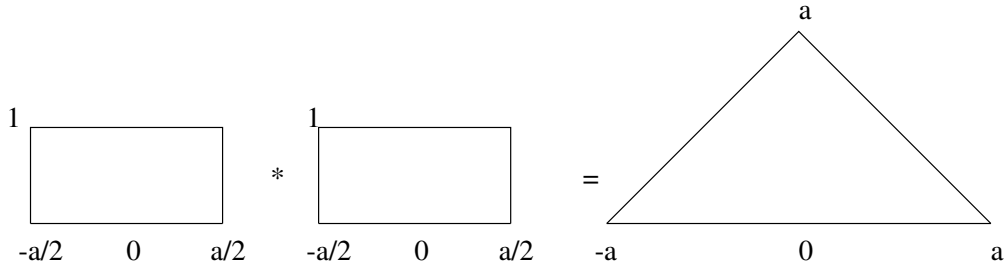

Figure 6.7: Convolution of two top hat functions.

This says that we replace the value of the signal at x , $f(x)$ by an average of all the values around x , displaced from x by an amount y and weighted by the function $g(y)$. This is an equivalent view of the process of blurring. Since it doesn't matter what we call the dummy integration variable, this rewriting of the integral shows that convolution is commutative: you can think of g blurring f or f blurring g :

$$f(x) * g(x) = \int_{-\infty}^{\infty} dz f(z)g(x - z) = \int_{-\infty}^{\infty} dz f(x - z)g(z) = g(x) * f(x). \quad (6.61)$$

6.1 Examples of convolution

1. Let $\Pi(x)$ be the top-hat function of width a .
 - $\Pi(x) * \Pi(x)$ is the triangular function of base width $2a$.
 - This is much easier to do by sketching than by working it out formally: see Figure 6.7.
2. Convolution of a general function $g(x)$ with a delta function $\delta(x - a)$.

$$\delta(x - a) * g(x) = \int_{-\infty}^{\infty} dx' \delta(x' - a)g(x - x') = g(x - a). \quad (6.62)$$

using the sifting property of the delta function. This is a clear example of the blurring effect of convolution: starting with a spike at $x = a$, we end up with a copy of the whole function $g(x)$, but now shifted to be centred around $x = a$. So here the 'sifting' property of a delta-function has become a 'shifting' property. Alternatively, we may speak of the delta-function becoming 'dressed' by a copy of the function g .

The response of the system to a delta function input (i.e. the function $g(x)$ here) is sometimes called the *Impulse Response Function* or, in an optical system, the *Point Spread Function*.

3. Making double slits: to form double slits of width a separated by distance $2d$ between centres:

$$[\delta(x + d) + \delta(x - d)] * \Pi(x). \quad (6.63)$$

We can form diffraction gratings with more slits by adding in more delta functions.

6.2 The convolution theorem

States that the Fourier transform of a *convolution* is a *product* of the individual Fourier transforms:

$$FT[f(x) * g(x)] = \tilde{f}(k) \tilde{g}(k) \quad (6.64)$$

$$FT[f(x) g(x)] = \frac{1}{2\pi} \tilde{f}(k) * \tilde{g}(k) \quad (6.65)$$

where $\tilde{f}(k)$, $\tilde{g}(k)$ are the FTs of $f(x)$, $g(x)$ respectively.

Note that:

$$\tilde{f}(k) * \tilde{g}(k) \equiv \int_{-\infty}^{\infty} dq \tilde{f}(q) \tilde{g}(k - q) . \quad (6.66)$$

We'll do one of these, and we will use the Dirac delta function.

The convolution $h = f * g$ is

$$h(x) = \int_{-\infty}^{\infty} f(x')g(x - x') dx' . \quad (6.67)$$

We substitute for $f(x')$ and $g(x - x')$ their FTs, noting the argument of g is not x' :

$$\begin{aligned} f(x') &= \frac{1}{2\pi} \int_{-\infty}^{\infty} \tilde{f}(k) e^{ikx'} dk \\ g(x - x') &= \frac{1}{2\pi} \int_{-\infty}^{\infty} \tilde{g}(k) e^{ik(x-x')} dk \end{aligned}$$

Hence (relabelling the k to k' in g , so we don't have two k integrals)

$$h(x) = \frac{1}{(2\pi)^2} \int_{-\infty}^{\infty} \left(\int_{-\infty}^{\infty} \tilde{f}(k) e^{ikx'} dk \int_{-\infty}^{\infty} \tilde{g}(k') e^{ik'(x-x')} dk' \right) dx' . \quad (6.68)$$

Now, as is very common with these multiple integrals, we do the integrations in a different order. Notice that the only terms which depend on x' are the two exponentials, indeed only part of the second one. We do this one first, using the fact that the integral gives 2π times a Dirac delta function:

$$\begin{aligned} h(x) &= \frac{1}{(2\pi)^2} \int_{-\infty}^{\infty} \tilde{f}(k) \int_{-\infty}^{\infty} \tilde{g}(k') e^{ik'x} \left(\int_{-\infty}^{\infty} e^{i(k-k')x'} dx' \right) dk' dk \\ &= \frac{1}{(2\pi)^2} \int_{-\infty}^{\infty} \tilde{f}(k) \int_{-\infty}^{\infty} \tilde{g}(k') e^{ik'x} [2\pi \delta(k - k')] dk' dk \end{aligned}$$

Having a delta function simplifies the integration enormously. We can do either the k or the k' integration immediately (it doesn't matter which you do – let us do k'):

$$\begin{aligned} h(x) &= \frac{1}{2\pi} \int_{-\infty}^{\infty} \tilde{f}(k) \left[\int_{-\infty}^{\infty} \tilde{g}(k') e^{ik'x} \delta(k - k') dk' \right] dk \\ &= \frac{1}{2\pi} \int_{-\infty}^{\infty} \tilde{f}(k) \tilde{g}(k) e^{ikx} dk \end{aligned}$$

Since

$$h(x) = \frac{1}{2\pi} \int_{-\infty}^{\infty} \tilde{h}(k) e^{ikx} dk \quad (6.69)$$

we see that

$$\tilde{h}(k) = \tilde{f}(k)\tilde{g}(k). \quad (6.70)$$

Note that we can apply the convolution theorem in reverse, going from Fourier space to real space, so we get the most important key result to remember about the convolution theorem:

$$\begin{aligned} \text{Convolution in real space} &\Leftrightarrow \text{Multiplication in Fourier space} \\ \text{Multiplication in real space} &\Leftrightarrow \text{Convolution in Fourier space} \end{aligned} \quad (6.71)$$

This is an important result. Note that if one has a convolution to do, it is often most efficient to do it with Fourier Transforms, not least because a very efficient way of doing them on computers exists – the *Fast Fourier Transform*, or FFT.

CONVENTION ALERT! Note that if we had chosen a different convention for the 2π factors in the original definitions of the FTs, the convolution theorem would look differently. Make sure you use the right one for the conventions you are using!

Note that convolution commutes, $f(x) * g(x) = g(x) * f(x)$, which is easily seen (e.g. since the FT is $\tilde{f}(k)\tilde{g}(k) = \tilde{g}(k)\tilde{f}(k)$.)

Example application: Fourier transform of the triangular function of base width $2a$. We know that a triangle is a convolution of top hats:

$$\Delta(x) = \Pi(x) * \Pi(x). \quad (6.72)$$

Hence by the convolution theorem:

$$FT[\Delta] = (FT[\Pi(x)])^2 = \left(\text{sinc} \frac{ka}{2}\right)^2 \quad (6.73)$$

FOURIER ANALYSIS: LECTURE 10

7 Parseval's theorem for FTs (Plancherel's theorem)

For FTs, there is a similar relationship between the average of the square of the function and the FT coefficients as there is with Fourier Series. For FTs it is strictly called *Plancherel's theorem*, but is often called the same as FS, i.e. Parseval's theorem; we will stick with Parseval. The theorem says

$$\int_{-\infty}^{\infty} |f(x)|^2 dx = \frac{1}{2\pi} \int_{-\infty}^{\infty} |\tilde{f}(k)|^2 dk. \quad (7.74)$$

It is useful to compare different ways of proving this:

(1) The first is to go back to Fourier series for a periodic $f(x)$: $f(x) = \sum_n c_n \exp(ik_n x)$, and $|f|^2$ requires us to multiply the series by itself, which gives lots of cross terms. But when we integrate over one fundamental period, all oscillating terms average to zero. Therefore the only terms that survive are ones where $c_n \exp(ik_n x)$ pairs with $c_n^* \exp(-ik_n x)$. This gives us Parseval's theorem for Fourier series:

$$\frac{1}{\ell} \int_{-\ell/2}^{\ell/2} |f(x)|^2 dx = \sum_n |c_n|^2 \Rightarrow \int_{-\ell/2}^{\ell/2} |f(x)|^2 dx = \ell \sum_n |c_n|^2 = \frac{1}{\ell} \sum_n |\tilde{f}|^2, \quad (7.75)$$

using the definition $\tilde{f} = \ell c_n$. But the mode spacing is $dk = 2\pi/\ell$, so $1/\ell$ is $dk/2\pi$. Now we take the continuum limit of $\ell \rightarrow \infty$ and $dk \sum$ becomes $\int dk$.

(2) Alternatively, we can give a direct proof using delta-functions:

$$|f(x)|^2 = f(x)f^*(x) = \left(\frac{1}{2\pi} \int \tilde{f}(k) \exp(ikx) dk \right) \times \left(\frac{1}{2\pi} \int \tilde{f}^*(k') \exp(-ik'x) dk' \right), \quad (7.76)$$

which is

$$\frac{1}{(2\pi)^2} \iint \tilde{f}(k) \tilde{f}^*(k') \exp[ix(k - k')] dk dk'. \quad (7.77)$$

If we now integrate over x , we generate a delta-function:

$$\int \exp[ix(k - k')] dx = (2\pi) \delta(k - k'). \quad (7.78)$$

So

$$\int |f(x)|^2 dx = \frac{1}{2\pi} \iint \tilde{f}(k) \tilde{f}^*(k') \delta(k - k') dk dk' = \frac{1}{2\pi} \int |\tilde{f}(k)|^2 dk. \quad (7.79)$$

7.1 Energy spectrum of decaying signal

As in the case of Fourier series, $|\tilde{f}(k)|^2$ is often called the *Power Spectrum* of the signal. If we have a field (such as an electric field) where the energy density is proportional to the *square* of the field, then we can interpret the square of the Fourier Transform coefficients as the *energy* associated with each frequency – i.e. total energy radiated is

$$\int_{-\infty}^{\infty} |f(t)|^2 dt. \quad (7.80)$$

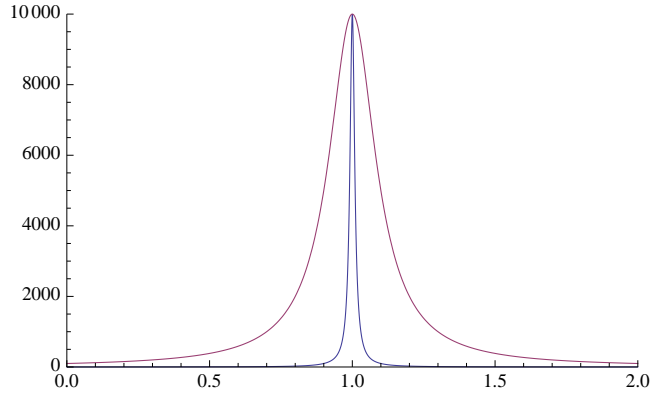

Figure 7.8: Frequency spectrum of two separate exponentially decaying systems with 2 different time constants τ . (x axis is frequency, y axis $\propto |\tilde{f}(\omega)|^2$ in arbitrary units).

By Parseval's theorem, this is equal to

$$\frac{1}{2\pi} \int_{-\infty}^{\infty} |\tilde{f}(\omega)|^2 d\omega. \quad (7.81)$$

and we interpret $|\tilde{f}(\omega)|^2/(2\pi)$ as the energy radiated per unit (angular) frequency, at frequency ω .

If we have a quantum transition from an upper state to a lower state, which happens spontaneously, then the intensity of emission will decay exponentially. We can model this semi-classically as a field that oscillates with frequency ω_0 , but with an amplitude that is damped with a timescale $\tau = 1/a$:

$$f(t) = e^{-at} \cos(\omega_0 t) \quad (t > 0). \quad (7.82)$$

Algebraically it is easier to write this as the real part of a complex exponential, do the FT with the exponential, and take the real part at the end. So consider

$$f(t) = \frac{1}{2} e^{-at} (e^{i\omega_0 t} + e^{-i\omega_0 t}) \quad (t > 0). \quad (7.83)$$

The Fourier transform is ¹

$$\begin{aligned} \tilde{f}(\omega) &= \frac{1}{2} \int_0^{\infty} (e^{-at-i\omega t+i\omega_0 t} + e^{-at-i\omega t-i\omega_0 t}) dt \\ \Rightarrow 2\tilde{f}(\omega) &= \left[\frac{e^{-at-i\omega t+i\omega_0 t}}{-a-i\omega+i\omega_0} - \frac{e^{-at-i\omega t-i\omega_0 t}}{-a-i\omega-i\omega_0} \right]_0^{\infty} \\ &= \frac{1}{(a+i\omega-i\omega_0)} + \frac{1}{(a+i\omega+i\omega_0)} \end{aligned} \quad (7.84)$$

$$(7.85)$$

This is sharply peaked near $\omega = \omega_0$; near this frequency, we therefore ignore the second term, and the frequency spectrum is

$$|\tilde{f}(\omega)|^2 \simeq \frac{1}{4 [a + i(\omega - \omega_0)] [a - i(\omega - \omega_0)]} = \frac{1}{4 [a^2 + (\omega - \omega_0)^2]}. \quad (7.86)$$

¹Note that this integral is *similar* to one which leads to Delta functions, but it isn't, because of the e^{-at} term. For this reason, you can integrate it by normal methods. If $a = 0$, then the integral does indeed lead to Delta functions.

This is a Lorentzian curve with width $a = 1/\tau$. Note that the width of the line in frequency is inversely proportional to the decay timescale τ . This is an example of the Uncertainty Principle, and relates the *natural width* of a spectral line to the decay rate. See Fig. 7.8.

8 Correlations and cross-correlations

Correlations are defined in a similar way to convolutions, but look carefully, as they are slightly different. With correlations, we are concerned with how similar functions are when one is displaced by a certain amount. If the functions are different, the quantity is called the *cross-correlation*; if it is the same function, it is called the *auto-correlation*, or simply *correlation*.

The cross-correlation of two functions is defined by

$$c(X) \equiv \langle f^*(x)g(x+X) \rangle \equiv \int_{-\infty}^{\infty} f^*(x)g(x+X) dx. \quad (8.87)$$

Compare this with convolution (equation 6.59). X is sometimes called the *lag*. Note that cross-correlation does not commute, unlike convolution. The most interesting special case is when f and g are the same function: then we have the *auto-correlation function*.

The meaning of these functions is easy to visualise if the functions are real: at zero lag, the auto-correlation function is then proportional to the variance in the function (it would be equal if we divided the integral by a length ℓ , where the functions are zero outside that range). So then the *correlation coefficient* of the function is

$$r(X) = \frac{\langle f(x)f(x+X) \rangle}{\langle f^2 \rangle}. \quad (8.88)$$

If r is small, then the values of f at widely separated points are unrelated to each other: the point at which r falls to 1/2 defines a characteristic width of a function. This concept is used particularly in random processes.

The FT of a cross-correlation is

$$\tilde{c}(k) = \tilde{f}^*(k) \tilde{g}(k). \quad (8.89)$$

This looks rather similar to the convolution theorem, which is hardly surprising given the similarity of the definitions of cross-correlation and convolution. Indeed, the result can be proved directly from the convolution theorem, by writing the cross-correlation as a convolution.

A final consequence of this is that the FT of an auto-correlation is just the power spectrum; or, to give the inverse relation:

$$\langle f^*(x)f(x+X) \rangle = \frac{1}{2\pi} \int |\tilde{f}|^2 \exp(ikX) dk. \quad (8.90)$$

This is known as the *Wiener-Khinchin theorem*, and it generalises Parseval's theorem (to which it reduces when $X = 0$). It is straightforward to prove directly, by writing the Fourier integral for f twice and using a delta-function; we will do this in the workshops.

Finally, note that much of this discussion applies also to periodic functions defined as Fourier series, where the proof is even easier.

$$f(x) = \sum_n c_n \exp(ik_n x) \Rightarrow f^*(x)f(x+X) = \sum_{n,m} c_n^* c_m \exp[i(k_m - k_n)x] \exp(ik_m X). \quad (8.91)$$

If we now interpret the averaging $\langle \dots \rangle$ as integrating in x over one period and dividing by the period, the $\exp[i(k_m - k_n)x]$ term yields just δ_{mn} . Hence

$$\langle f^*(x)f(x+X) \rangle = \sum_n |c_n|^2 \exp(ik_n X). \quad (8.92)$$

9 Fourier analysis in multiple dimensions

We have now completed all the major tools of Fourier analysis, in one spatial dimension. In many cases, we want to consider more than one dimension, and the extension is relatively straightforward. Start with the fundamental Fourier series, $f(x) = \sum_n c_n \exp(i2\pi nx/\ell_x)$. $f(x)$ can be thought of as $F(x, y)$ at constant y ; if we change y , the effective $f(x)$ changes, so the c_n must depend on y . Hence we can Fourier expand these as a series in y :

$$c_n(y) = \sum_m d_{nm} \exp(i2\pi my/\ell_y), \quad (9.93)$$

where we assume that the function is periodic in x , with period ℓ_x , and y , with period ℓ_y . The overall series is then

$$F(x, y) = \sum_{n,m} d_{nm} \exp[2\pi i(n x/\ell_x + m y/\ell_y)] = \sum_{n,m} d_{nm} \exp[i(k_x x + k_y y)] = \sum_{n,m} d_{nm} \exp[i(\mathbf{k} \cdot \mathbf{x})]. \quad (9.94)$$

This is really just the same as the 1D form, and the extension to D dimensions should be obvious. In the end, we just replace the usual kx term with the dot product between the position vector and the wave vector.

The Fourier transform in D dimensions just involves taking the limit of $\ell_x \rightarrow \infty$, $\ell_y \rightarrow \infty$ etc. The Fourier coefficients become a continuous function of \mathbf{k} , in which case we can sum over bins in k space, each containing $N_{\text{modes}}(\mathbf{k})$ modes:

$$F(\mathbf{x}) = \sum_{\text{bin}} d(\mathbf{k}) \exp[i(\mathbf{k} \cdot \mathbf{x})] N_{\text{modes}}. \quad (9.95)$$

The number of modes in a given k -space bin is set by the period in each direction: allowed modes lie on a grid of points in the space of k_x, k_y etc. as shown in Figure 9.9. If for simplicity the period is the same in all directions, the *density of states* is $\ell^D/(2\pi)^D$:

$$N_{\text{modes}} = \frac{\ell^D}{(2\pi)^D} d^D k. \quad (9.96)$$

This is an important concept which is used in many areas of physics.

The Fourier expression of a function is therefore

$$F(\mathbf{x}) = \frac{1}{(2\pi)^D} \int \tilde{F}(\mathbf{k}) \exp[i(\mathbf{k} \cdot \mathbf{x})] d^D k, \quad (9.97)$$

Where we have defined $\tilde{F}(\mathbf{k}) \equiv \ell^D d(\mathbf{k})$. The inverse relation would be obtained as in 1D, by appealing to orthogonality of the modes:

$$\tilde{F}(\mathbf{k}) = \int F(\mathbf{x}) \exp[-i(\mathbf{k} \cdot \mathbf{x})] d^D x. \quad (9.98)$$

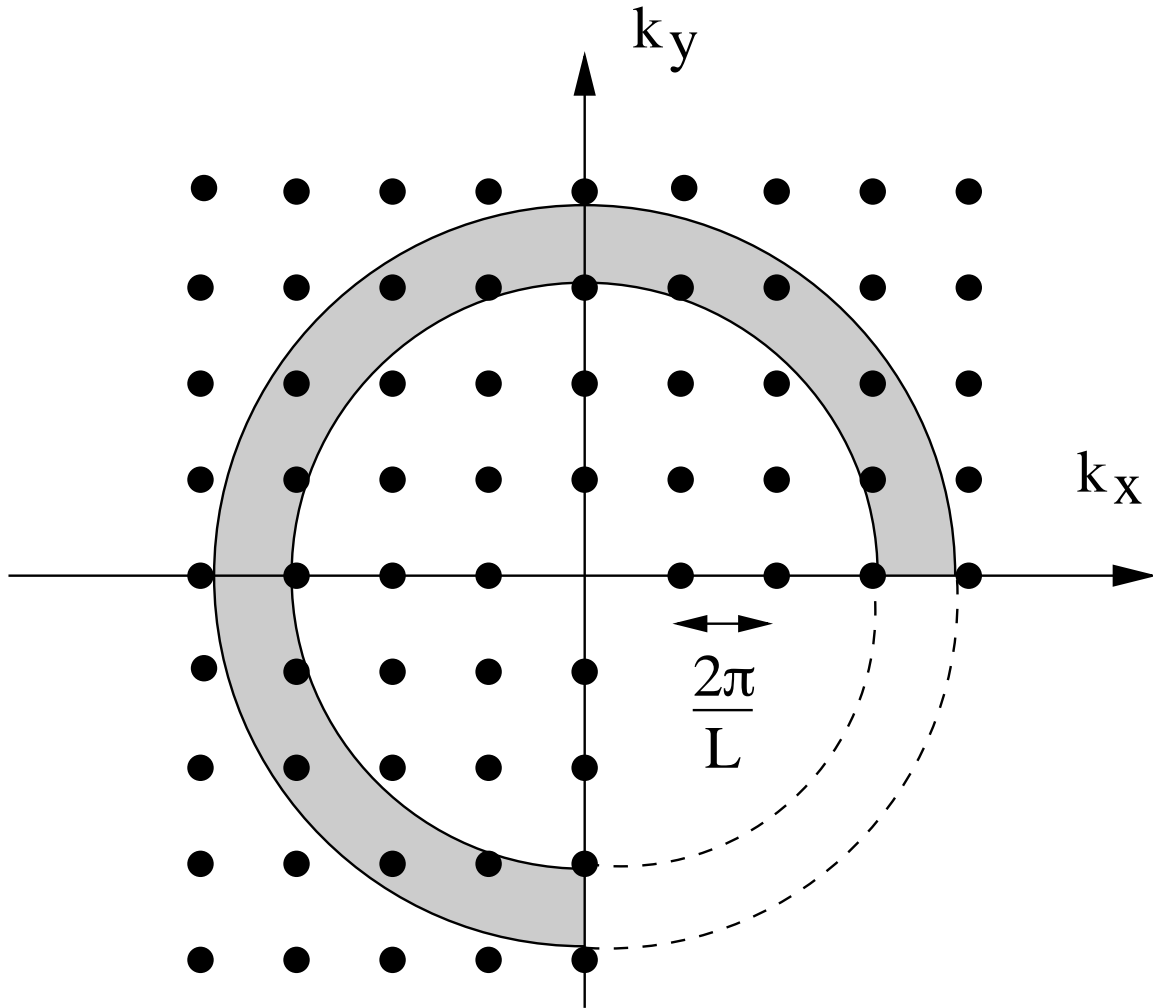

Figure 9.9: Illustrating the origin of the density of states in 2D. The allowed modes are shown as points, with a separation in k_x and k_y of $2\pi/\ell$, where ℓ is the periodicity. The number of modes between $|k|$ and $|k| + d|k|$ (i.e. inside the shaded annulus) is well approximated by $(\ell/2\pi)^2$ times the area of the annulus, as $\ell \rightarrow \infty$, and the mode spacing tends to zero. Clearly, in D dimensions, the mode density is just $(\ell/2\pi)^D$.

FOURIER ANALYSIS: LECTURE 11

10 Digital analysis and sampling

Imagine we have a continuous signal (e.g. pressure of air during music) which we sample by making measurements at a few particular times. Any practical storage of information must involve this step of *analogue-to-digital conversion*. This means we are converting a continuous function into one that is only known at discrete points – i.e. we are throwing away information. We would feel a lot more comfortable doing this if we knew that the missing information can be recovered, by some form of interpolation between the sampled points. Intuitively, this seems reasonable if the sampling interval is very fine: by the definition of continuity, the function between two sampled points should be arbitrarily close to the average of the sample values as the locations of the samples gets closer together. But the sampling interval has to be finite, so this raises the question of how coarse it can be; clearly we would prefer to use as few samples as possible consistent with not losing any information. This question does have a well-posed answer, which we can derive using Fourier methods.

The first issue is how to represent the process of converting a function $f(x)$ into a set of values $\{f(x_i)\}$. We can do this by using some delta functions:

$$f(x) \rightarrow f_s(x) \equiv f(x) \sum_i \delta(x - x_i). \quad (10.99)$$

This replaces our function by a sum of spikes at the locations x_i , each with a weight $f(x_i)$. This representation of the sampled function holds the information of the sample values and locations. So, for example, if we try to average the sampled function over some range, we automatically get something proportional to just adding up the sample values that lie in the range:

$$\int_{x_1}^{x_2} f_s(x) dx = \sum_{\text{in range}} f(x_i). \quad (10.100)$$

10.1 The infinite comb

If we sample regularly with a spacing Δx , then we have an ‘infinite comb’ – an infinite series of delta functions. The comb is (see Fig. 10.10):

$$g(x) = \sum_{j=-\infty}^{\infty} \delta(x - j\Delta x) \quad (10.101)$$

This is also known as the *Shah function*.

To compute the FT of the Shah function, we will write it in another way. This is derived from the fact that the function is periodic, and therefore suitable to be written as a Fourier *series* with $\ell = \Delta x$:

$$g(x) = \sum_n c_n \exp(2\pi nix/\Delta x). \quad (10.102)$$

The coefficients c_n are just

$$c_n = \frac{1}{\Delta x} \int_{-\Delta x/2}^{\Delta x/2} \delta(x) dx = \frac{1}{\Delta x}, \quad (10.103)$$

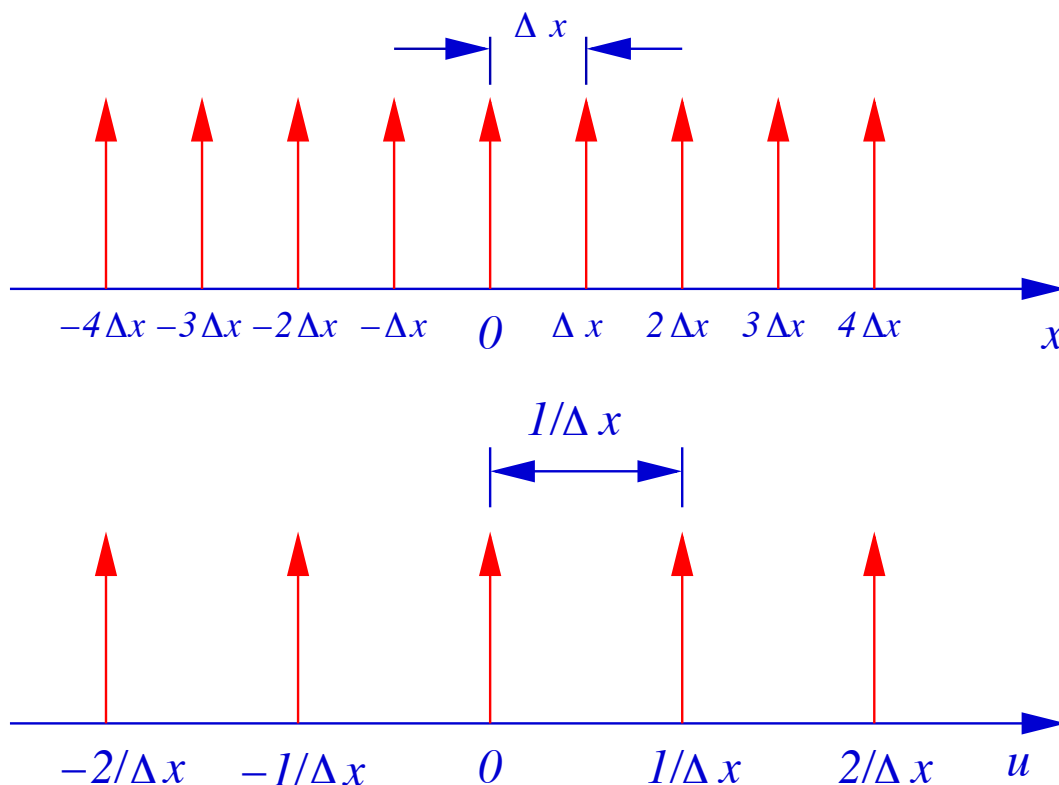

Figure 10.10: Top: An infinite comb in real space. This represents the sampling pattern of a function which is sampled regularly every Δx . Bottom: The FT of the infinite comb, which is also an infinite comb. Note that u here is $k/(2\pi)$.

so that

$$g(x) = \frac{1}{\Delta x} \sum_n \exp(2\pi nix/\Delta x) = \frac{1}{2\pi} \int \tilde{g}(k) \exp(ikx) dx. \quad (10.104)$$

From this, we can see that $\tilde{g}(k)$ must involve a sum of delta-functions in k space, since $g(x)$ has ended up as a sum of $\exp(ik_n x)$ terms, each of which could be sifted out of the Fourier integral by a contribution to $\tilde{g}(k)$ that is $\propto \delta(k - k_n)$. More formally, we could take the FT of our new expression for $g(x)$, which would yield a series of delta-functions. In any case,

$$\tilde{g}(k) = \frac{2\pi}{\Delta x} \sum_{n=-\infty}^{\infty} \delta(k - 2\pi n/\Delta x). \quad (10.105)$$

which is an infinite comb in Fourier space, with spacing $2\pi/\Delta x$.

The FT of a function sampled with an infinite comb is therefore ($1/2\pi$ times) the convolution of this and the FT of the function:

$$\tilde{f}_s(k) = \frac{1}{2\pi} \tilde{f}(k) * \tilde{g}(k) = \frac{1}{\Delta x} \sum_{n=-\infty}^{\infty} \tilde{f}(k - 2\pi n/\Delta x). \quad (10.106)$$

In other words, each delta-function in the k -space comb becomes ‘dressed’ with a copy of the transform of the original function.

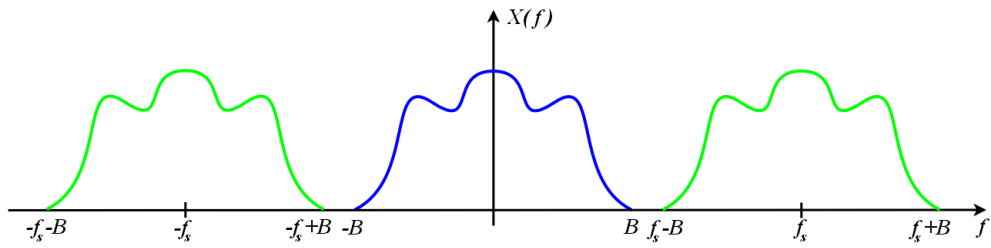

Figure 10.11: If the sampling is fine enough, then the original spectrum can be recovered from the sampled spectrum.

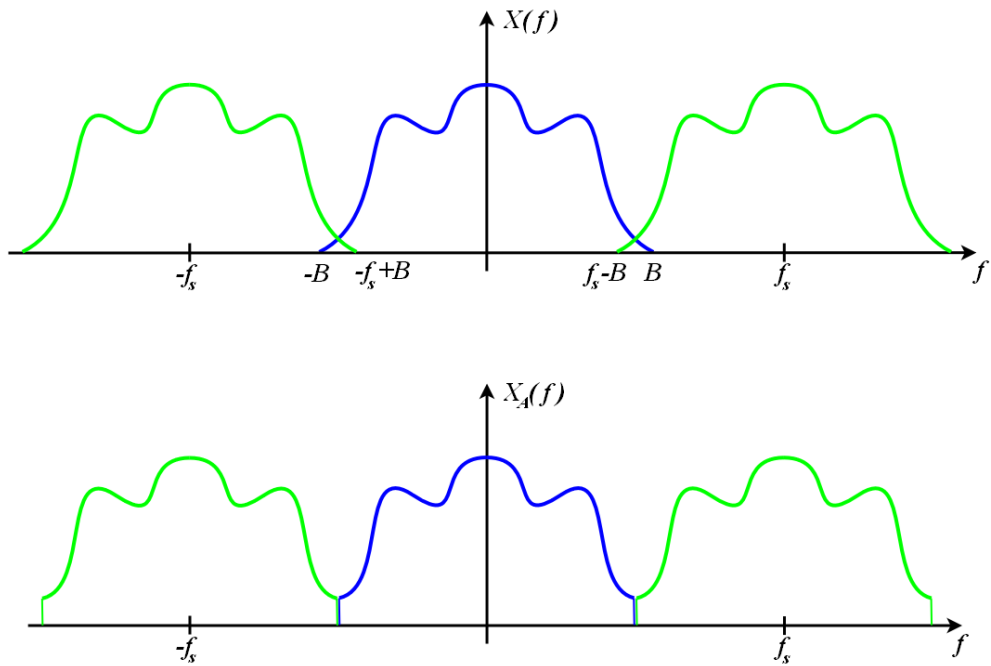

Figure 10.12: If the sampling is *not* fine enough, then the power at different frequencies gets mixed up, and the original spectrum cannot be recovered.

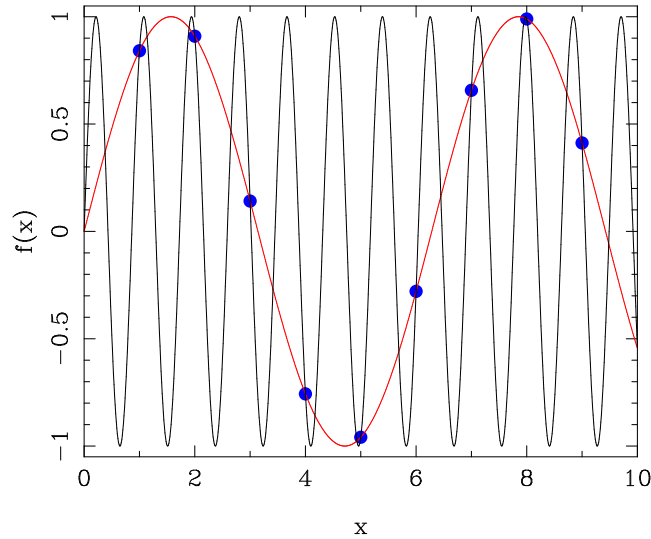

Figure 10.13: If $\sin t$ is sampled at unit values of t , then $\sin(t + 2\pi t)$ is indistinguishable at the sampling points. The sampling theorem says we can only reconstruct the function between the samples if we know that high-frequency components are absent.

10.2 Shannon sampling, aliasing and the Nyquist frequency

We can now go back to the original question: do the sampled values allow us to reconstruct the original function exactly? An equivalent question is whether the transform of the sampled function allows us to reconstruct the transform of the original function.

The answer is that this is possible (a) if the original spectrum is *bandlimited*, which means that the power is confined to a finite range of wavenumber (i.e. there is a maximum wavenumber k_{max} which has non-zero Fourier coefficients); and (b) if the sampling is fine enough. This is illustrated in Figs 10.11 and 10.12. If the sampling is not frequent enough, the power at different wavenumbers gets mixed up. This is called *aliasing*. The condition to be able to measure the spectrum accurately is to have a sample at least as often as the *Shannon Rate*

$$\Delta x = \frac{1}{\pi k_{max}}. \quad (10.107)$$

The Nyquist wavenumber is defined as

$$k_{\text{Nyquist}} = \frac{\pi}{\Delta x} \quad (10.108)$$

which needs to exceed the maximum wavenumber in order to avoid aliasing:

$$k_{\text{Nyquist}} \geq k_{max}. \quad (10.109)$$

For time-sampled data (such as sound), the same applies, with wavenumber k replaced by frequency ω .

There is a simple way of seeing that this makes sense, as illustrated in Figure 10.13. Given samples of a Fourier mode at a certain interval, Δx , a mode with a frequency increased by any multiple of $2\pi/\Delta x$ clearly has the same result at the sample points.

10.2.1 Interpolation of samples

The idea of having data that satisfy the sampling theorem is that we should be able to reconstruct the full function from the sampled values; how do we do this in practice? If the sampled function is the product of $f(x)$ and the Shah function, we have seen that the FT of the sampled function is the same as $\tilde{f}/\Delta x$, for $|k| < \pi/\Delta x$. If we now multiply by $\tilde{T}(k)$: a top-hat in k space, extending from $-\pi/\Delta x$ to $+\pi/\Delta x$, with height Δx , then we have exactly \tilde{f} and can recover $f(x)$ by an inverse Fourier transform. This k -space multiplication amounts to convolving the sampled data with the inverse Fourier transform of $T(k)$, so we recover $f(x)$ in the form

$$f(x) = [f(x)g(x)]*T(x) = \int f(q) \sum_n \delta(q-n\Delta x) T(x-q) dq = \int \sum_n f(n\Delta x) \delta(q-n\Delta x) T(x-q) dq, \quad (10.110)$$

using $f(x)\delta(x-a) = f(a)\delta(x-a)$. The sum of delta-functions sifts to give

$$f(x) = \sum_n f(n\Delta x)T(x-n\Delta x), \quad (10.111)$$

i.e. the function $T(x) = \sin[\pi x/\Delta x]/(\pi x/\Delta x)$ is the interpolating function. This is known as ‘sinc interpolation’.

FOURIER ANALYSIS: LECTURE 12

10.3 CDs and compression

Most human beings can hear frequencies in the range 20 Hz – 20 kHz. The sampling theorem means that the sampling frequency needs to be at least 40 kHz to capture the 20 kHz frequencies. The CD standard samples at 44.1 kHz. The data consist of stereo: two channels each encoded as 16-bit integers. Allowing one bit for sign, the largest number encoded is thus $2^{15} - 1 = 32767$. This allows signals of typical volume to be encoded with a fractional precision of around 0.01% – an undetectable level of distortion. This means that an hour of music uses about 700MB of information. But in practice, this requirement can be reduced by about a factor 10 without noticeable degradation in quality. The simplest approach would be to reduce the sampling rate, or to encode the signal with fewer bits. The former would require a reduction in the maximum frequency, making the music sound dull; but fewer bits would introduce distortion from the quantization of the signal. The solution implemented in the MP3 and similar algorithms is more sophisticated than this: the time series is split into ‘frames’ of 1152 samples (0.026 seconds at CD rates) and each is Fourier transformed. Compression is achieved by storing simply the amplitudes and phases of the strongest modes, as well as using fewer bits to encode the amplitudes of the weaker modes, according to a ‘perceptual encoding’ where the operation of the human ear is exploited – knowing how easily faint tones of a given frequency are masked by a loud one at a different frequency.

10.4 Prefiltering

If a signal does not obey the sampling theorem, it must be modified to do so before digitization. Analogue electronics can suppress high frequencies – although they are not completely removed. The sampling process itself almost inevitably performs this task to an extent, since it is unrealistic to imagine that one could make an instantaneous sample of a waveform. Rather, the sampled signal is probably an average of the true signal over some period.

This is easily analysed using the convolution theorem. Suppose each sample, taken at an interval τ , is the average of the signal over a time interval T , centred at the sample time. This is a convolution:

$$f_c(t) = \int f(t')g(t-t') dt', \quad (10.112)$$

where $g(t-t')$ is a top hat of width T centred on $t' = t$. We therefore know that

$$\tilde{f}_c(\omega) = \tilde{f}(\omega) \sin(\omega T/2)/(\omega T/2). \quad (10.113)$$

At the Nyquist frequency, π/τ , the Fourier signal in f is suppressed by a factor $\sin(\pi T/2\tau)/(\pi T/2\tau)$. The natural choice of T would be the same as τ (accumulate an average signal, store it, and start again). This gives $\sin(\pi/2)/(\pi/2) = 0.64$ at the Nyquist frequency, so aliasing is not strongly eliminated purely by ‘binning’ the data, and further prefiltering is required before the data can be sampled.

11 Discrete Fourier Transforms & the FFT

This section is added to the course notes as a non-examinable supplement, which may be of interest to those using numerical Fourier methods in project work. We have explored the properties of

sampled data using the concept of an infinite array of delta functions, but this is not yet a practical form that can be implemented on a computer.

11.1 The DFT

Suppose that we have a function, $f(x)$, that is periodic with period ℓ , and which is known only at N equally spaced values $x_n = n(\ell/N)$. Suppose also that $f(x)$ is band-limited with a maximum wavenumber that satisfies $|k_{\max}| < \pi/(\ell/N)$, i.e. it obeys the sampling theorem. If we wanted to describe this function via a Fourier series, we would need the Fourier coefficients

$$f_k(k) = \frac{1}{\ell} \int_0^\ell f(x) \exp[-ikx] dx. \quad (11.114)$$

This integral can clearly be approximated by summing over the N sampled values:

$$f_k(k) = \frac{1}{\ell} \sum_n f(x_n) \exp[-ikx_n] \ell/N = \frac{1}{N} \sum_n f(x_n) \exp[-ikx_n]; \quad (11.115)$$

in fact, we show below that this expression yields the exact integral for data that obey the sampling theorem. The range of grid values is irrelevant because of the periodicity of f . Suppose we sum from $n = 1$ to N and then change to $n = 0$ to $N - 1$: the sum changes by $f(x_0) \exp[-ikx_0] - f(x_N) \exp[-ikx_N]$, but $f(x_0) = f(x_N)$ and $x_N - x_0 = \ell$. Since the allowed values of k are multiples of $2\pi/\ell$, the change in the sum vanishes. We can therefore write what can be regarded as the definition of the *discrete Fourier transform* of the data:

$$f_k(k_m) = \frac{1}{N} \sum_{n=0}^{N-1} f(x_n) \exp[-ik_m x_n], \quad (11.116)$$

where the allowed values of k are $k_m = m(2\pi/\ell)$ and the allowed values of x are $x_n = n(\ell/N)$. This expression has an inverse of very similar form:

$$f(x_j) = \sum_{m=0}^{N-1} f_k(k_m) \exp[ik_m x_j]. \quad (11.117)$$

To prove this, insert the first definition in the second, bearing in mind that $k_m x_n = 2\pi mn/N$. This gives the expression

$$\frac{1}{N} \sum_{m,n} f(x_n) \exp[2\pi im(j-n)/N] = \frac{1}{N} \sum_{m,n} f(x_n) z^m, \quad (11.118)$$

where $z = \exp[2\pi i(j-n)/N]$. Consider $\sum_m z^m$: where $j = n$ we have $z = 1$ and the sum is N . But if $j \neq n$, the sum is zero. To show this, consider $z \sum_m z^m = \sum_m z^m + z^N - 1$. But $z^N = 1$, and we have $z \sum_m z^m = \sum_m z^m$, requiring the sum to vanish if $z \neq 1$. Hence $\sum_m z^m = N\delta_{jn}$, and this orthogonality relation proves that the inverse is exact.

An interesting aspect of the inverse as written is that it runs only over positive wavenumbers; don't we need k to be both positive and negative? The answer comes from the gridding in x and k : since $k_m x_n = 2\pi mn/N$, letting $m \rightarrow m + N$ has no effect. Thus a mode with $m = N - 1$ is equivalent to one with $m = -1$ etc. So the k -space array stores increasing positive wavenumbers in its first elements, jumping to large negative wavenumbers once k exceeds the Nyquist frequency. In a little

more detail, the situation depends on whether N is odd or even. If it is odd, then $m = (N + 1)/2$ is an integer equivalent to $-(N - 1)/2$, so the successive elements $m = (N - 1)/2$ and $m = (N + 1)/2$ hold the symmetric information near to the Nyquist frequency, $|k| = (N - 1)/N \times \pi/(\ell/N)$. On the other hand, if N is even, we have a single mode exactly at the Nyquist frequency: $m = N/2 \Rightarrow |k| = (N/2)(2\pi/\ell) = \pi/(\ell/N)$. This seems at first as though the lack of pairing of modes at positive and negative k may cause problems with enforcing the Hermitian symmetry needed for a real $f(x)$, this is clearly not the case, since we can start with a real f and generate the N Fourier coefficients as above.

Finally, we should prove how this connects with our experience with using Fourier series. Here we would say

$$f_k(k) = \frac{1}{\ell} \int_0^\ell f(x) \exp[-ikx] dx. \quad (11.119)$$

We have taken the integral over 0 to ℓ rather than symmetrically around zero, but the same Fourier coefficient arises as long as we integrate over one period. Now, we have seen that the exact function can be interpolated from the sampled values:

$$f(x) = \sum_{n=-\infty}^{\infty} f(nX)T(x - nX) = \sum_{m=-\infty}^{\infty} \sum_{n=0}^{N-1} f([n + mN]X)T(x - [n + mN]X), \quad (11.120)$$

where $X = \ell/N$, T is the sinc interpolation function, and the second form explicitly sums over all the periodic repetitions of f . Putting this into the integral for f_k gives

$$f_k = \frac{1}{\ell} \sum_{m,n} f([n + mN]X) \int_0^\ell T(x - [n + mN]X) \exp[-ix] dx \quad (11.121)$$

$$= \frac{1}{\ell} \sum_{m,n} f([n + mN]X) \exp[-ik(n + mN)X] \int_{y_1}^{y_2} T(y) \exp[-iky] dy \quad (11.122)$$

$$= \frac{1}{\ell} \sum_{n=0}^{N-1} f(nX) \exp[-iknX] \sum_{m=-\infty}^{\infty} \int_{y_1}^{y_2} T(y) \exp[-iky] dy \quad (11.123)$$

$$= \frac{1}{\ell} \sum_{n=0}^{N-1} f(nX) \exp[-iknX] \int_{-\infty}^{\infty} T(y) \exp[-iky] dy. \quad (11.124)$$

The successive simplifications use (a) the fact that f is periodic, so $f(x + NX) = f(x)$; (b) the fact that allowed wavenumbers are a multiple of $2\pi/\ell$, so kNX is a multiple of 2π ; (c) recognising that the y limits are $y_1 = -(n + mN)X$ and $y_2 = \ell - (n + mN)X$, so that summing over m joins together segments of length ℓ into an integral over all values of y . But as we saw in section 10.2.1, the integral has the constant value X while $|k|$ is less than the Nyquist frequency. Thus, for the allowed values of k , $f_k = (1/N) \sum_{n=0}^{N-1} f(nX) \exp[-iknX]$, so that the DFT gives the exact integral for the Fourier coefficient.

11.2 The FFT

We have seen the advantages of the DFT in data compression, meaning that it is widely used in many pieces of contemporary consumer electronics. There is therefore a strong motivation to compute the DFT as rapidly as possible; the Fast Fourier Transform does exactly this.

At first sight, there may seem little scope for saving time. If we define the complex number $W \equiv \exp[-i2\pi/N]$, then the DFT involves us calculating the quantity

$$F_m \equiv \sum_{n=0}^{N-1} f_n W^{nm}. \quad (11.125)$$

The most time-consuming part of this calculation is the complex multiplications between f_n and powers of W . Even if all the powers of W are precomputed and stored, there are still $N - 1$ complex multiplications to carry out for each of $N - 1$ non-zero values of m , so apparently the time for DFT computation scales as N^2 for large N .

The way to evade this limit is to realise that many of the multiplications are the same, because $W^N = 1$ but W^{nm} has nm reaching large multiples of N – up to $(N - 1)^2$. As an explicit example, consider $N = 4$:

$$F_0 = f_0 + f_1 + f_2 + f_3 \quad (11.126)$$

$$F_1 = f_0 + f_1 W + f_2 W^2 + f_3 W^3 \quad (11.127)$$

$$F_2 = f_0 + f_1 W^2 + f_2 W^4 + f_3 W^6 \quad (11.128)$$

$$F_3 = f_0 + f_1 W^3 + f_2 W^6 + f_3 W^9. \quad (11.129)$$

There are apparently 9 complex multiplications (plus a further 5 if we need to compute the powers W^2, W^3, W^4, W^6, W^9). But the only distinct powers needed are W^2 & W^3 . The overall transform can then be rewritten saving four multiplications: removing a redundant multiplication by W^4 ; recognising that the same quantities appear in more than one F_i ; and that some multiplications distribute over addition:

$$F_0 = f_0 + f_1 + f_2 + f_3 \quad (11.130)$$

$$F_1 = f_0 + f_2 W^2 + W(f_1 + f_3 W^2) \quad (11.131)$$

$$F_2 = f_0 + f_2 + W^2(f_1 + f_3) \quad (11.132)$$

$$F_3 = f_0 + f_2 W^2 + W^3(f_1 + f_3 W^2). \quad (11.133)$$

So now there are 5 multiplications, plus 2 for the powers: a reduction from 14 to 7.

It would take us too far afield to discuss how general algorithms for an FFT are constructed to achieve the above savings for any value of N . The book *Numerical Recipes* by Press et al. (CUP) has plenty of detail. The result is that the naive $\sim N^2$ time requirement can be reduced to $\sim N \ln N$, provided N has only a few small prime factors – most simply a power of 2.

FOURIER ANALYSIS: LECTURE 13

12 Ordinary Differential Equations

A powerful application of Fourier methods is in the solution of differential equations. This is because of the following identity for the FT of a derivative:

$$FT [f^{(p)}(x)] = FT \left[\frac{d^p f}{dx^p} \right] = (ik)^p \tilde{f}(k) \quad (12.134)$$

Thus applying a FT to terms involving derivatives replaces the *differential* equation with an *algebraic* equation for \tilde{f} , which may be easier to solve.

Let's remind ourselves of the origin of this fundamental result. The simplest approach is to write a function $f(x)$ as a Fourier integral: $f(x) = \int \tilde{f}(k) \exp(ikx) dk/2\pi$. Differentiation with respect to x can be taken inside the integral, so that $df/dx = \int \tilde{f}(k) ik \exp(ikx) dk/2\pi$. From this we can immediately recognise $ik\tilde{f}(k)$ as the FT of df/dx . The same argument can be made with a Fourier series.

We will illustrate the application of this result with the familiar example of the driven damped simple harmonic oscillator.

12.1 The driven damped Simple Harmonic Oscillator

Probably the most familiar physical context for this equation is where we have a mass m attached to a spring with a spring constant k , and which is also immersed in a viscous fluid that exerts a resistive force proportional to the speed of the mass, with a constant of proportionality D . Imagine further that the mass is driven by an external force $F(t)$. The equation of motion for the displacement $z(t)$ is

$$m\ddot{z} = -kz - D\dot{z} + F(t) \quad (12.135)$$

(negative signs in $-kz - D\dot{z}$ because both spring and drag oppose motion in the z direction). Now define a characteristic frequency by $\omega_0^2 = k/m$, and let $\gamma = D/m$. Then we can write the equation in what will be our standard form:

$$\ddot{z} + \gamma\dot{z} + \omega_0^2 z = f(t), \quad (12.136)$$

where $f(t) = F(t)/m$.

The identical equation arises in an LCR electrical circuit consisting of an inductor of inductance L , a capacitor of capacitance C and a resistor of resistance R . If they are in series, then in the simplest case of one of each in the circuit, the voltage across all three is the sum of the voltages across each component. The voltage across R is IR , where I is the current; across the inductor it is LdI/dt , and across the capacitor it is Q/C , where Q is the charge on the capacitor:

$$V(t) = L \frac{dI}{dt} + RI + \frac{Q}{C}. \quad (12.137)$$

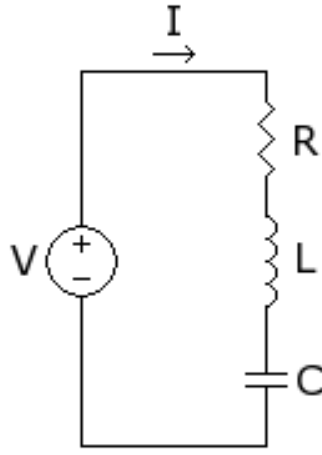

Figure 12.14: A simple series LCR circuit.

Now, since the rate of change of charge on the capacitor is simply the current, $dQ/dt = I$, we can differentiate this equation, to get a second-order ODE for I :

$$L \frac{d^2 I}{dt^2} + R \frac{dI}{dt} + \frac{I}{C} = \frac{dV}{dt}. \quad (12.138)$$

This is the same differential equation as before, with

$$(z, \gamma, \omega_0^2, f) \rightarrow (I, R/L, 1/LC, \dot{V}/L). \quad (12.139)$$

12.1.1 Periodic driving force

The simplest case to consider is where the driving force oscillates at a single frequency, ω . Let's look at how this is often solved, without using any Fourier terminology. We can always choose the origin of time so that $f(t) = A \cos \omega t$, so we want to solve $\ddot{z} + \gamma \dot{z} + \omega_0^2 z = A \cos \omega t$. The normal approach is to guess that z must respond at the same frequency, so that $z = a \cos \omega t + b \sin \omega t$. Substituting this guess, we get

$$(\omega_0^2 - \omega^2)(a \cos \omega t + b \sin \omega t) + \gamma \omega (-a \sin \omega t + b \cos \omega t) = A \cos \omega t. \quad (12.140)$$

In order for the lhs to be a pure cos, the sin coefficient must vanish: $b(\omega_0^2 - \omega^2) - a\gamma\omega = 0$. Equating cos coefficients then gives $a(\omega_0^2 - \omega^2) + b\gamma\omega = A$. These equations can be written in matrix form:

$$\begin{pmatrix} (\omega_0^2 - \omega^2) & \gamma\omega \\ -\gamma\omega & (\omega_0^2 - \omega^2) \end{pmatrix} \begin{pmatrix} a \\ b \end{pmatrix} = \begin{pmatrix} A \\ 0 \end{pmatrix}. \quad (12.141)$$

So inverting the matrix gives

$$\begin{pmatrix} a \\ b \end{pmatrix} = \frac{1}{\gamma^2 \omega^2 + (\omega_0^2 - \omega^2)^2} \begin{pmatrix} (\omega_0^2 - \omega^2) & -\gamma\omega \\ \gamma\omega & (\omega_0^2 - \omega^2) \end{pmatrix} \begin{pmatrix} A \\ 0 \end{pmatrix}. \quad (12.142)$$

Hence the solution is

$$z = A [(\omega_0^2 - \omega^2)^2 + \gamma^2 \omega^2]^{-1} [(\omega_0^2 - \omega^2) \cos \omega t + \gamma\omega \sin \omega t]. \quad (12.143)$$

Because of the occurrence of sin and cos terms, there is a phase shift with respect to the driving term, so we must be able to write this as $z = z_0 \cos(\omega t + \phi)$, and expressions for the amplitude and phase could be obtained with a bit of trigonometric effort. But there is an easier way.

12.1.2 Complex solution

Write the driving term as $f = A \exp(i\omega t)$. The normal justification for this complex approach is that we will take the real part at the end. This is fair enough, but we will give a better justification later. Note that the amplitude A could be complex, $A = |A| \exp(i\phi)$, so we can easily include a phase in the input signal; in the real formalism, we chose the origin of time so that this phase vanished, otherwise the algebra would have been even messier. If we now try a solution $z = c \exp(i\omega t)$, where again c can include a phase, we get

$$-\omega^2 c + i\gamma\omega c + \omega_0^2 c = A, \quad (12.144)$$

since the $\exp(i\omega t)$ factor on each side can be divided out. This gives us the solution for c immediately with almost no work.

The result can be made a bit more intuitive by splitting the various factors into amplitudes and phases. Let $A = |A| \exp(i\phi)$ and $(-\omega^2 + i\gamma\omega + \omega_0^2) = |B| \exp(i\alpha)$, where

$$|B| = \sqrt{(\omega_0^2 - \omega^2)^2 + \gamma^2\omega^2} \quad (12.145)$$

and

$$\tan \alpha = \gamma\omega / (\omega_0^2 - \omega^2). \quad (12.146)$$

Then we have simply

$$z(t) = \frac{|A|}{|B|} \exp[i(\omega t + \phi - \alpha)], \quad (12.147)$$

so the dynamical system returns the input oscillation, modified in amplitude by the factor $1/|B|$ and lagging in phase by α . For small frequencies, this phase lag is very small; it becomes $\pi/2$ when $\omega = \omega_0$; for larger ω , the phase lag tends to π .

The same equations can be obtained using the real approach, but it takes a great deal longer. Once again, we see the advantage of the complex formalism.

12.2 Fourier approach

The above traditional approach works, but it can seem a little ad hoc. We guess form for the solution (how did we know to make this guess?), and we have to remember to take the real part of a complex calculation and throw away the imaginary part. But Fourier analysis allows us to be more systematic. The key point is that the differential equations of interest are linear in the unknown, z , and in its derivatives. Since the FT is also a linear operation, we immediately get an equation relating the Fourier transforms of z and f :

$$\ddot{z} + \gamma\dot{z} + \omega_0^2 z = f(t) \Rightarrow -\omega^2 \tilde{z}(\omega) + i\omega\gamma \tilde{z}(\omega) + \omega_0^2 \tilde{z}(\omega) = \tilde{f}(\omega), \quad (12.148)$$

because the FT of $\dot{z}(t)$ is $i\omega \tilde{z}(\omega)$, and the FT of $\ddot{z}(t)$ is $-\omega^2 \tilde{z}(\omega)$. Thus

$$\tilde{z}(\omega) = \frac{\tilde{f}(\omega)}{\omega_0^2 - \omega^2 + i\gamma\omega}. \quad (12.149)$$

This solution in Fourier space is general and works for any time-dependent force. Once we have a specific form for the force, we can in principle use the Fourier expression to obtain the exact solution for $z(t)$, assuming we can do the necessary integrals.

As a simple example, consider a driving force that can be written as a single complex exponential:

$$f(t) = A \exp(i\Omega t). \quad (12.150)$$

Fourier transforming, we get

$$\tilde{f}(\omega) = \int_{-\infty}^{\infty} A e^{i\Omega t} e^{-i\omega t} dt = 2\pi A \delta(\Omega - \omega) = 2\pi A \delta(\omega - \Omega). \quad (12.151)$$

Unsurprisingly, the result is a δ -function spike at the driving frequency. Since we know that $\tilde{z}(\omega) = \tilde{f}(\omega)/(\omega_0^2 - \omega^2 + i\gamma\omega)$, we can now use the inverse FT to compute $z(t)$:

$$\begin{aligned} z(t) &= \frac{1}{2\pi} \int_{-\infty}^{\infty} \frac{\tilde{f}(\omega)}{\omega_0^2 - \omega^2 + i\gamma\omega} e^{i\omega t} d\omega \\ &= A \int_{-\infty}^{\infty} \frac{\delta(\omega - \Omega)}{\omega_0^2 - \omega^2 + i\gamma\omega} e^{i\omega t} d\omega \\ &= A \frac{\exp(i\Omega t)}{\omega_0^2 - \Omega^2 + i\gamma\Omega} = \frac{|A|}{|B|} \exp(i\Omega t + \phi - \alpha), \end{aligned} \quad (12.152)$$

where $A = |A| \exp(i\phi)$ and $\omega_0^2 - \Omega^2 + i\gamma\Omega = |B| \exp(i\alpha)$. This is just the answer we obtained by taking the usual route of trying a solution proportional to $\exp(i\Omega t)$ – but the nice thing is that the inverse FT has produced this for us automatically, without needing to guess.

Finally, we can also clarify the common use of complex exponentials to represent real oscillations. The traditional argument is that (as long as we deal with linear equations) the real and imaginary parts process separately and so we can just take the real part at the end. But in Fourier analysis, we have noted that real functions require the Hermitian symmetry $\tilde{f}(\omega) = \tilde{f}^*(-\omega)$. If $f(t)$ is to be real, it therefore makes no sense to consider purely a signal at a single ω : we must allow for the negative-frequency part simultaneously. If there is to be a spike in \tilde{f} at $\omega = +\Omega$, we therefore need a corresponding spike at $\omega = -\Omega$:

$$\tilde{f}(\omega) = 2\pi A \delta(\omega - \Omega) + 2\pi A^* \delta(\omega + \Omega). \quad (12.153)$$

The inverse Fourier transform of this is just a real oscillation with arbitrary phase:

$$f(t) = A \exp(i\Omega t) + A^* \exp(-i\Omega t) = 2|A| \cos(\Omega t + \phi), \quad (12.154)$$

where $A = |A| \exp(i\phi)$. Notice that this $f(t)$ is the sum of a complex exponential and its conjugate, so we have

$$f(t) = 2\text{Re}[A \exp(i\Omega t)]. \quad (12.155)$$

Thus the Hermitian symmetry between positive and negative frequencies ends up instructing us to adopt exactly the traditional approach: solve the problem with $f \propto \exp(i\Omega t)$ and take the real part at the end.

Finally, then, the time-dependent solution when we insist on this real driving force of given frequency comes simply from adding the previous solution to its complex conjugate:

$$z(t) = \frac{|A|}{|B|} \exp[i(\Omega t + \phi - \alpha)] + \frac{|A|}{|B|} \exp[-i(\Omega t + \phi - \alpha)] = 2 \frac{|A|}{|B|} \cos(\Omega t + \phi - \alpha). \quad (12.156)$$

The factor 2 is unimportant; it also occurs in the definition of $f(t) = 2|A| \cos(\Omega t + \phi)$, so it can be absorbed in the definition of $|A|$.

FOURIER ANALYSIS: LECTURE 14

12.3 Periodic vs non-periodic forces

The Fourier Transform approach does not assume the driving force, or the response, to be periodic. It's worth contrasting explicitly this general approach with what we do when the force is periodic with period T (i.e. $f(t + T) = f(t)$ for all t).

In this case, we expand both f and z as Fourier Series. If we use a sin+cos series, then

$$\begin{aligned} z(t) &= \frac{1}{2}a_0 + \sum_{n=1}^{\infty} a_n \cos(\omega_n t) + \sum_{n=1}^{\infty} b_n \sin(\omega_n t) \\ f(t) &= \frac{1}{2}A_0 + \sum_{n=1}^{\infty} A_n \cos(\omega_n t) + \sum_{n=1}^{\infty} B_n \sin(\omega_n t) \end{aligned} \quad (12.157)$$

where $\omega_n = 2\pi n/T$.

$$\begin{aligned} \frac{dz}{dt} &= -\sum_{n=1}^{\infty} \omega_n a_n \sin(\omega_n t) + \sum_{n=1}^{\infty} n\omega b_n \cos(n\omega t) \\ \frac{d^2z(t)}{dt^2} &= -\sum_{n=1}^{\infty} \omega_n^2 a_n \cos(\omega_n t) - \sum_{n=1}^{\infty} \omega_n^2 b_n \sin(\omega_n t) \end{aligned} \quad (12.158)$$

Then the l.h.s. of the differential equation becomes

$$\ddot{z} + \gamma\dot{z} + \omega_0^2 z = \frac{\omega_0^2}{2}a_0 + \sum_{n=1}^{\infty} [(-\omega_n^2 a_n + \gamma\omega_n b_n + \omega_0^2 a_n) \cos(\omega_n t) + (-\omega_n^2 b_n - \gamma\omega_n a_n + \omega_0^2 b_n) \sin(\omega_n t)]. \quad (12.159)$$

This Fourier series must match the one for $f(t)$. Now, because of the orthogonality of the sin & cos modes, we can extract from either side the coefficients corresponding to a given sin or cos mode, which must then match on either side of the equation, mode-by-mode. In the traditional solution of the problem, this same matching approach is taken, but without the formal justification from orthogonality.

Similarly, for a complex series of a periodic force, we would write

$$z(t) = \sum_n c_n \exp(i\omega_n t); \quad f(t) = \sum_n d_n \exp(i\omega_n t), \quad (12.160)$$

giving

$$\ddot{z} + \gamma\dot{z} + \omega_0^2 z = \sum_n [(\omega_0^2 - \omega_n^2) + i\gamma\omega_n] c_n \exp(i\omega_n t). \quad (12.161)$$

Again, using orthogonality to justify equating coefficients, we would deduce

$$c_n = d_n / [(\omega_0^2 - \omega_n^2) + i\gamma\omega_n], \quad (12.162)$$

Which is the same relation we found between \tilde{z} and \tilde{f} when we took the direct Fourier Transform of the differential equation.

12.4 Complex impedance

In the previous lecture, we looked at using Fourier transforms to solve the differential equation for the damped harmonic oscillator. It's illuminating to reconsider this analysis in the specific context of the LCR circuit, where $L\ddot{I} + R\dot{I} + I/C = \dot{V}$. Let the voltage be a complex oscillation, $V = \tilde{V} \exp(i\omega t)$, so that the current is of the same form, $I = \tilde{I} \exp(i\omega t)$, obeying

$$-\omega^2 L \tilde{I} + i\omega R \tilde{I} + \frac{1}{C} \tilde{I} = i\omega \tilde{V}, \quad (12.163)$$

Thus we see that the circuit obeys a form of Ohm's law, but involving a *complex impedance*, Z :

$$\tilde{V} = Z(\omega) \tilde{I}; \quad Z(\omega) = R + i\omega L - \frac{i}{\omega C}. \quad (12.164)$$

This is a very useful concept, as it immediately allows more complex circuits to be analysed, using the standard rules for adding resistances in series or in parallel.

The frequency dependence of the impedance means that different kinds of LCR circuit have functions as *filters* of the time-dependent current passing through them: different Fourier components (i.e. different frequencies) can be enhanced or suppressed. For example, consider a resistor and inductor in series:

$$\tilde{I}(\omega) = \frac{\tilde{V}(\omega)}{R + i\omega L}. \quad (12.165)$$

For high frequencies, the current tends to zero; for $\omega \ll R/L$, the output of the circuit (current over voltage) tends to the constant value $I(\omega)/V(\omega) = R$. So this would be called a *low-pass filter*: it only transmits low-frequency vibrations. Similarly, a resistor and capacitor in series gives

$$\tilde{I}(\omega) = \frac{\tilde{V}}{R + (i\omega C)^{-1}}. \quad (12.166)$$

This acts as a *high-pass filter*, removing frequencies below about $(RC)^{-1}$. Note that the LR circuit can also act in this way if we measure the voltage across the inductor, V_L , rather than the current passing through it:

$$\tilde{V}_L(\omega) = i\omega L \tilde{I}(\omega) = i\omega L \frac{\tilde{V}}{R + i\omega L} = \frac{\tilde{V}}{1 + R(i\omega L)^{-1}}. \quad (12.167)$$

Finally, a full series LCR circuit is a *band-pass filter*, which removes frequencies below $(RC)^{-1}$ and above R/L from the current.

12.5 Resonance

It is interesting to look at the solution to the damped harmonic oscillator in a bit more detail. If the forcing term has a very high frequency ($\omega \gg \omega_0$) then $|B|$ is large and the amplitude is suppressed – the system cannot respond to being driven much faster than its natural oscillation frequency. In fact the amplitude is greatest if ω is about ω_0 (if γ is small). We can differentiate to show that the maximum amplitude is reached at the *resonant frequency*:

$$\omega = \omega_{\text{res}} = \sqrt{\omega_0^2 - \gamma^2/2}. \quad (12.168)$$

When γ is small, this is close to the natural frequency of the oscillator: $\omega_{\text{res}} \simeq \omega_0 - \gamma^2/4\omega_0$.

The amplitude of the oscillation falls rapidly as we move away from resonance. To see this, write $|B|^2 = (\omega_0^2 - \omega^2)^2 + \gamma^2\omega^2$ in terms of $\omega^2 = \omega_{\text{res}}^2 + x$:

$$|B|^2 = \gamma^2\omega_{\text{res}}^2 - \gamma^4/4 + x^2. \quad (12.169)$$

If we write $\omega = \omega_{\text{res}} + \epsilon$, then $x \simeq 2\omega_{\text{res}}\epsilon$ to lowest order in ϵ . If $\gamma \ll \omega_0$, we can now neglect the difference between ω_{res} and ω_0 , so that the amplitude of oscillation becomes approximated by the following expression:

$$\frac{1}{|B|^2} \simeq \frac{(\gamma\omega_0)^{-2}}{(1 + 4\epsilon^2/\gamma^2)}. \quad (12.170)$$

This is a *Lorentzian* dependence of the square of the amplitude on frequency deviation from resonance. The width of the resonance is set by the damping: moving a frequency $\epsilon = \gamma/2$ away from resonance halves the squared amplitude.

12.6 Transients

Finally, note that we can always add a solution to the homogeneous equation (i.e. where we set the right hand side to zero). The final solution will be determined by the initial conditions (z and dz/dt). This is because the equation is *linear* and we can superimpose different solutions. For this additional solution (also called the *complementary function*), we try an oscillating solution $z \propto \exp(i\omega t)$. Substituting in the damped oscillator differential equation gives the *auxiliary equation*:

$$-\omega^2 + i\gamma\omega + \omega_0^2 = 0, \quad (12.171)$$

a quadratic equation with the solution $\omega = i\gamma/2 \pm \sqrt{-\gamma^2/4 + \omega_0^2}$. There are two main cases to consider:

(1) *Underdamped*: $\gamma/2 < \omega_0$. $z = e^{-\gamma t/2}(Ae^{i\Omega t} + Be^{-i\Omega t})$, where $\Omega = \sqrt{-\gamma^2/4 + \omega_0^2}$.

(2) *Overdamped*: $\gamma/2 > \omega_0$. $z = e^{-\gamma t/2}(Ae^{\Omega' t} + Be^{-\Omega' t})$, where $\Omega' = \sqrt{\gamma^2/4 - \omega_0^2}$.

So there is only oscillation if the damping is not too high. For very heavy damping, $e^{-\gamma t/2}Ae^{\Omega' t}$ yields very nearly a time independent z , as is physically reasonable for an extremely viscous fluid. But in all cases, the solution damps to zero as $t \rightarrow \infty$. Therefore, if the initial conditions require a component of the homogeneous solution, this only causes an *initial transient*, and the solution settles down to the *steady-state response*, which is what was calculated earlier.

One mathematical complication arises with *critical damping*: $\gamma/2 = \omega_0$, so that the two roots coincide at $\Omega = 0$. The simplest way of seeing how to deal with this is to imagine that Ω is non-zero but very small. Thus $Ae^{\Omega' t} + Be^{-\Omega' t} \simeq (A + B) + (A - B)\Omega' t$. So the critically damped solution is $z = e^{-\gamma t/2}(C + Dt)$ (you can check that this does solve the critically-damped equation exactly). One might also consider generalising the equation so that γ or ω_0^2 are negative. This changes the physical behaviour and interpretation (e.g. we will now get runaway solutions that increase with time), but no new algebraic issues arise.

Whatever the form of the complementary function, it presents a problem for the Fourier solution of the differential equation, especially with a periodic driving force: in general the undriven motion of the system will not share this periodicity, and hence it cannot be described by a Fourier series. As a result, the Fourier solution is always zero if the Fourier components of the driving force vanish, even though this is unphysical: an oscillator displaced from $z = 0$ will show motion even in the absence of an applied force. For a proper treatment of this problem, we have to consider the boundary

conditions of the problem, which dictate the amount of the homogeneous solution to be added to yield the complete solution.

When dealing with Fourier transforms, this step may seem inappropriate. The Fourier transform describes non-periodic functions that stretch over an infinite range of time, so it may seem that boundary conditions can only be set at $t = -\infty$. Physically, we would normally lack any reason for a displacement in this limit, so the homogeneous solution would tend to be ignored – even though it should be included as a matter of mathematical principle. In fact, we will eventually see that the situation is not this simple, and that boundary conditions have a subtle role in yielding the correct solution even when using Fourier methods.

12.7 Approach using convolution

The solution to differential equations using Fourier methods automatically generates an answer in the form of a product in Fourier space, so a little thought and a memory of the convolution theorem shows that the result can be presented in term of a convolution.

Let's illustrate this point with a simple example that bears some resemblance to the harmonic oscillator:

$$\frac{d^2 z}{dt^2} - \omega_0^2 z = f(t). \quad (12.172)$$

Taking the FT gives

$$-\omega^2 \tilde{z}(\omega) - \omega_0^2 \tilde{z}(\omega) = \tilde{f}(\omega) \Rightarrow \tilde{z}(\omega) = \frac{-\tilde{f}(\omega)}{\omega_0^2 + \omega^2}, \quad (12.173)$$

with a solution

$$z(t) = -\frac{1}{2\pi} \int_{-\infty}^{\infty} \frac{\tilde{f}(\omega)}{\omega_0^2 + \omega^2} e^{i\omega t} d\omega. \quad (12.174)$$

What this says is that a single oscillating $f(t)$, with amplitude a , will generate a response in antiphase with the applied oscillation, with amplitude $-a/(\omega_0^2 + \omega^2)$. For the general case, we superimpose oscillations of different frequency, which is what the inverse Fourier transform does for us.

But now we see that the FT of $z(t)$ is a product (in Fourier space), of $\tilde{f}(\omega)$ and

$$\tilde{g}(\omega) \equiv \frac{-1}{\omega_0^2 + \omega^2} \quad (12.175)$$

hence the solution is a convolution in real (i.e. time) space:

$$z(t) = \int_{-\infty}^{\infty} f(t') g(t - t') dt'. \quad (12.176)$$

An exercise for you is to show that the FT of

$$g(t) = -\frac{e^{-\omega_0|t|}}{2\omega_0} \quad (12.177)$$

is $\tilde{g}(\omega) = -1/(\omega_0^2 + \omega^2)$, so we finally arrive at the steady solution for a driving force $f(t)$:

$$z(t) = -\frac{1}{2\omega_0} \int_{-\infty}^{\infty} f(t') e^{-\omega_0|t-t'|} dt'. \quad (12.178)$$

Note how we have used $g(t - t') = -e^{-\omega_0|t-t'|}/2\omega_0$ here, as required for a convolution.

FOURIER ANALYSIS: LECTURE 15

13 Green's functions

13.1 Response to an impulse

We have spent some time so far in applying Fourier methods to solution of differential equations such as the damped oscillator. These equations are all in the form of

$$Ly(t) = f(t), \quad (13.179)$$

where L is a *linear* differential operator. For the damped harmonic oscillator, $L = (d^2/dt^2 + \gamma d/dt + \omega_0^2)$. As we know, linearity is an important property because it allows superposition: $L(y_1 + y_2) = Ly_1 + Ly_2$. It is this property that lets us solve equations in general by the method of *particular integral plus complementary function*: guess a solution that works for the given driving term on the RHS, and then add any solution of the homogeneous equation $Ly = 0$; this is just adding zero to each side, so the sum of the old and new y functions still solves the original equation.

In this part of the course, we focus on a very powerful technique for finding the solution to such problems by considering a very simple form for the RHS: an impulse, where the force is concentrated at a particular instant. A good example would be striking a bell with a hammer: the subsequent ringing is the solution to the equation of motion. This *impulse response function* is also called a *Green's function* after George Green, who invented it in 1828 (note the apostrophe: this is not a Green function). We have to specify the time at which we apply the impulse, T , so the applied force is a delta-function centred at that time, and the Green's function solves

$$LG(t, T) = \delta(t - T). \quad (13.180)$$

Notice that the Green's function is a function of t and of T separately, although in simple cases it is also just a function of $t - T$.

This may sound like a peculiar thing to do, but the Green's function is everywhere in physics. An example where we can use it without realising is in electrostatics, where the electrostatic potential satisfies Poisson's equation:

$$\nabla^2 \phi = -\rho/\epsilon_0, \quad (13.181)$$

where ρ is the charge density. What is the Green's function of this equation? It is the potential due to a charge of value $-\epsilon_0$ at position vector \mathbf{q} :

$$G(\mathbf{r}, \mathbf{q}) = \frac{-1}{4\pi|\mathbf{r} - \mathbf{q}|}. \quad (13.182)$$

13.2 Superimposing impulses

The reason it is so useful to know the Green's function is that a general RHS can be thought of as a superposition of impulses, just as a general charge density arises from summing individual point charges. We have seen this viewpoint before in interpreting the sifting property of the delta-function:

$$f(x) = \int f(q) \delta(x - q) dq. \quad (13.183)$$

To repeat, we normally tend to think of this as involving a single spike located at $q = x$, which pulls out the value of f at the location of this spike. But we can flip the viewpoint and think of $\delta(x - q)$ as specifying a spike at $x = q$, where now the integral covers all values of q : spikes everywhere. Alternatively, consider the analogy with the inverse Fourier transform:

$$f(x) = \int \tilde{f}(k)/2\pi \exp(ikx), dk. \quad (13.184)$$

Here, we have basis functions $\exp(ikx)$, which we think of as functions of x with k as a parameter, with expansion coefficients $\tilde{f}(k)/2\pi$. From this point of view, the sifting relation uses $\delta(x - q)$ as the basis function, with q as the parameter specifying where the spike is centred.

So if $f(x)$ is a superposition of spikes, we only need to understand the response of a linear system to one spike and then superposition of responses will give the general solution. To show this explicitly, take $LG(t, T) = \delta(t - T)$ and multiply both sides by $f(T)$ (which is a constant). But now integrate both sides over T , noting that L can be taken outside the integral because it doesn't depend on T :

$$L \int G(t, T)f(T) dT = \int \delta(t - T)f(T) dT = f(t). \quad (13.185)$$

The last step uses sifting to show that indeed adding up a set of impulses on the RHS, centred at differing values of T , has given us $f(t)$. Therefore, the general solution is a superposition of the different Green's functions:

$$y(t) = \int G(t, T)f(T) dT. \quad (13.186)$$

This says that we apply a force $f(T)$ at time T , and the Green's function tells us how to propagate its effect to some other time t (so the Green's function is also known as a *propagator*).

13.2.1 Importance of boundary conditions

When solving differential equations, the solution is not unique until we have applied some boundary conditions. This means that the Green's function that solves $LG(t, T) = \delta(t - T)$ also depends on the boundary conditions. This shows the importance of having boundary conditions that are *homogeneous*: in the form of some linear constraint(s) being zero, such as $y(a) = y(b) = 0$, or $y(a) = y(b) = 0$. If such conditions apply to $G(t, T)$, then a solution that superimposes $G(t, T)$ for different values of T will still satisfy the boundary condition. This would not be so for $y(a) = y(b) = 1$, and the problem would have to be manipulated into one for which the boundary conditions were homogeneous – by writing a differential equation for $z \equiv y - 1$ in that case.

13.3 Finding the Green's function

The above method is general, but to find the Green's function it is easier to restrict the form of the differential equation. To emphasise that the method is not restricted to dependence on time, now consider a spatial second-order differential equation of the general form

$$\frac{d^2y}{dx^2} + a_1(x)\frac{dy}{dx} + a_0(x)y(x) = f(x). \quad (13.187)$$

Now, if we can solve for the *complementary function* (i.e. solve the equation for zero RHS), the Green's function can be obtained immediately. This is because a delta function vanishes almost

everywhere. So if we now put $f(x) \rightarrow \delta(x - z)$, then the solution we seek is a solution of the homogeneous equation everywhere except at $x = z$.

We split the range into two, $x < z$, and $x > z$. In each part, the r.h.s. is zero, so we need to solve the homogeneous equation, subject to the boundary conditions at the edges. At $x = z$, we have to be careful to match the solutions together. The δ function is infinite here, which tells us that the *first* derivative must be discontinuous, so when we take the second derivative, it diverges. The first derivative must change discontinuously by 1. To see this, integrate the equation between $z - \epsilon$ and $z + \epsilon$, and let $\epsilon \rightarrow 0$:

$$\int_{z-\epsilon}^{z+\epsilon} \frac{d^2y}{dx^2} dx + \int_{z-\epsilon}^{z+\epsilon} a_1(x) \frac{dy}{dx} dx + \int_{z-\epsilon}^{z+\epsilon} a_0(x) dx = \int_{z-\epsilon}^{z+\epsilon} \delta(x - z) dx. \quad (13.188)$$

The second and third terms vanish as $\epsilon \rightarrow 0$, as the integrands are finite, and the r.h.s. integrates to 1, so

$$\left. \frac{dy}{dx} \right|_{z+\epsilon} - \left. \frac{dy}{dx} \right|_{z-\epsilon} = 1. \quad (13.189)$$

13.3.1 Example

Consider the differential equation

$$\frac{d^2y}{dx^2} + y = x \quad (13.190)$$

with boundary conditions $y(0) = y(\pi/2) = 0$.

The Green's function is continuous at $x = z$, has a discontinuous derivative there, and satisfies the same boundary conditions as y . From the properties of the Dirac delta function, except at $x = z$, the Green's function satisfies

$$\frac{d^2G(x, z)}{dx^2} + G(x, z) = 0. \quad (13.191)$$

(Strictly, we might want to make this a partial derivative, at fixed z . It is written this way so it looks like the equation for y). This is a harmonic equation, with solution

$$G(x, z) = \begin{cases} A(z) \sin x + B(z) \cos x & x < z \\ C(z) \sin x + D(z) \cos x & x > z. \end{cases} \quad (13.192)$$

We now have to adjust the four unknowns A, B, C, D to match the boundary conditions.

The boundary condition $y = 0$ at $x = 0$ means that $B(z) = 0$, and $y = 0$ at $x = \pi/2$ implies that $C(z) = 0$. Hence

$$G(x, z) = \begin{cases} A(z) \sin x & x < z \\ D(z) \cos x & x > z. \end{cases} \quad (13.193)$$

Continuity of G implies that $A(z) \sin z = D(z) \cos z$ and a discontinuity of 1 in the derivative implies that $-D(z) \sin z - A(z) \cos z = 1$. We have 2 equations in two unknowns, so we can eliminate A or D :

$$-A(z) \frac{\sin^2 z}{\cos z} - A(z) \cos z = 1 \Rightarrow A(z) = \frac{-\cos z}{\sin^2 z + \cos^2 z} = -\cos z \quad (13.194)$$

and consequently $D(z) = -\sin z$. Hence the Green's function is

$$G(x, z) = \begin{cases} -\cos z \sin x & x < z \\ -\sin z \cos x & x > z \end{cases} \quad (13.195)$$

The solution for a driving term x on the r.h.s. is therefore (be careful here with which solution for G to use: the first integral on the r.h.s. has $x > z$)

$$y(x) = \int_0^{\pi/2} z G(x, z) dz = -\cos x \int_0^x z \sin z dz - \sin x \int_x^{\pi/2} z \cos z dz. \quad (13.196)$$

Integrating by parts,

$$y(x) = (x \cos x - \sin x) \cos x - \frac{1}{2}(\pi - 2 \cos x - 2x \sin x) \sin x = x - \frac{\pi}{2} \sin x. \quad (13.197)$$

13.4 Summary

So to recap, the procedure is to find the Green's function by

- replacing the driving term by a Dirac delta function
- solving the homogeneous equation either side of the impulse, *with the same boundary conditions e.g. $G = 0$ at two boundaries, or $G = \partial G/\partial x = 0$ at one boundary.*
- Note the *form* of the solution will be the same for (e.g.) $x < z$ and $x > z$, but the *coefficients* (strictly, they are not constant coefficients, but rather functions of z) will differ either side of $x = z$.
- matching the solutions at $x = z$ (so $G(x, z)$ is continuous).
- introducing a discontinuity of 1 in the first derivative $\partial G(x, z)/\partial x$ at $x = z$
- integrating the Green's function with the actual driving term to get the full solution.

FOURIER ANALYSIS: LECTURE 16

13.5 Boundary conditions at the same place/time

The boundary conditions strongly influence the nature of the Green's function. We can demonstrate this with the case where the boundary conditions act at a single point, rather than two points as above.

Of course, the number of boundary conditions depends on the order of the equation. The simplest case is a first-order equation, where only one condition is required. Suppose we want to solve

$$\frac{dy}{dt} - g(t)y = f(t), \quad (13.198)$$

subject to $y = 0$ at $t = 0$. The homogeneous solution is easily obtained by direct integration:

$$y = A \exp \left[\int_0^t g(t') dt' \right] \quad (13.199)$$

Thus $G = 0$ in the region of time containing the origin ($t < T$ if $T > 0$ and $t > T$ if $T < 0$). Now our matching condition is just that $G = 1$ on the other side of the spike. Thus if $T > 0$ then

$$G(t, T) = \exp \left[\int_T^t g(t') dt' \right]. \quad (13.200)$$

13.5.1 Second-order example

Now for a second-order example. Consider a frictionless particle acted on by an exponentially declining force that is switched on at $t = 0$, at which point the particle is at rest:

$$\frac{d^2z}{dt^2} = e^{-t}; \quad (13.201)$$

$$z = 0; \quad \frac{dz}{dt} = 0 \quad \text{at } t = 0. \quad (13.202)$$

We can, of course, solve this equation very easily simply by integrating twice, and applying the boundary conditions. As an exercise, we are going to solve it with Green's functions. This also makes the point that there is often more than one way to solve a problem.

For an impulse at T , the Green's function satisfies

$$\frac{\partial G(t, T)}{\partial t^2} = \delta(t - T) \quad (13.203)$$

so for $t < T$ and $t > T$ the equation to be solved is $\partial^2 G / \partial t^2 = 0$, which has solution

$$G(t, T) = \begin{cases} A(T)t + B(T) & t < T \\ C(T)t + D(T) & t > T \end{cases} \quad (13.204)$$

Now, we apply the same boundary conditions. $G(t = 0) = 0 \Rightarrow B = 0$. The derivative $G'(t = 0) = 0 \Rightarrow A = 0$, so $G(t, T) = 0$ for $t < T$.

Continuity of G at $t = T$ implies

$$C(T)T + D(T) = 0, \quad (13.205)$$

and a discontinuity of 1 in the derivative at T implies that

$$C(T) - A(T) = 1. \quad (13.206)$$

Hence $C = 1$ and $D = -T$ and the Green's function is

$$G(t, T) = \begin{cases} 0 & t < T \\ t - T & t > T \end{cases} \quad (13.207)$$

The full solution is then

$$z(t) = \int_0^\infty G(t, T)f(T)dT \quad (13.208)$$

where $f(T) = e^{-T}$. Hence

$$z(t) = \int_0^t G(t, T)f(T)dT + \int_t^\infty G(t, T)f(T)dT. \quad (13.209)$$

The second integral vanishes, because $G = 0$ for $t < T$, so

$$z(t) = \int_0^t (t - T)e^{-T}dT = t [-e^{-T}]_0^t - \left\{ [-Te^{-T}]_0^t + \int_0^t e^{-T}dT \right\} \quad (13.210)$$

which gives the motion as

$$z(t) = t - 1 + e^{-t}. \quad (13.211)$$

We can check that $z(0) = 0$, that $z'(0) = 0$, and that $z''(t) = e^{-t}$. The final speed is $z'(t \rightarrow \infty) = 1$.

13.6 Causality

The above examples showed how the boundary conditions influence the Green's function. Boundary conditions at the single point $t = 0$ have enforced the causal behaviour

$$G(t, T) = 0 \quad (t < T); \quad (13.212)$$

i.e. nothing happens before the impulse is applied. This seems physically reasonable. On the other hand, this result only applies for $T > 0$: if $T < 0$ then the Green's function is anti-causal and vanishes for $t > T$. What's going on?

One answer is that there is nothing special about $t = 0$ for the boundary conditions. If we let the point at which they are applied approach $t \rightarrow -\infty$ then all impulses will come later than the point at which the boundary conditions are applied. This makes more physical sense: we put down our system at rest and afterwards apply forces to it. So the causal Green's function is always the case of practical interest.

As one further example, consider the harmonic oscillator:

$$\ddot{G}(t, T) + \omega_0^2 G(t, T) = \delta(t - T). \quad (13.213)$$

The causal Green's function is particularly easy to find, because we only need to think about the behaviour at $t > T$. Here, the solution of the homogeneous equation is $A \sin \omega_0 t + B \cos \omega_0 t$, which must vanish at $t = T$. Therefore it can be written as $G(t, T) = A \sin[\omega_0(t - T)]$. The derivative must be unity at $t = T$, so the causal Green's function for the undamped harmonic oscillator is

$$G(t, T) = \frac{1}{\omega_0} \sin[\omega_0(t - T)]. \quad (13.214)$$

13.6.1 Comparison with direct Fourier solution

As a further example, we can revisit again the differential equation with the opposite sign from the oscillator:

$$\frac{d^2 z}{dt^2} - \omega_0^2 z = f(t). \quad (13.215)$$

We solved this above by taking the Fourier transform of each side, to obtain

$$z(t) = -\frac{1}{2\pi} \int_{-\infty}^{\infty} \frac{\tilde{f}(\omega)}{\omega_0^2 + \omega^2} e^{i\omega t} d\omega. \quad (13.216)$$

We then showed that this is in the form of a convolution:

$$z(t) = -\frac{1}{2\omega_0} \int_{-\infty}^{\infty} f(T) e^{-\omega_0|t-T|} dT. \quad (13.217)$$

This looks rather similar to the solution in terms of the Green's function, so can we say that $G(t, T) = -\exp(-\omega_0|t - T|)/2\omega_0$? Direct differentiation gives $\dot{G} = \pm \exp(-\omega_0|t - T|)/2$, with the + sign for $t > T$ and the - sign for $t < T$, so it has the correct jump in derivative and hence satisfies the equation for the Green's function.

But this is a rather strange expression, since it is symmetric in time: a response at t can precede T . The problem is that we have imposed no boundary conditions. If we insist on causality, then $G = 0$ for $t < T$ and $G = A \exp[\omega_0(t - T)] + B \exp[-\omega_0(t - T)]$ for $t > T$. Clearly $A = -B$, so $G = 2A \sinh[\omega_0(t - T)]$. This now looks similar to the harmonic oscillator, and a unit step in \dot{G} at $t = T$ requires

$$G(t, T) = \frac{1}{\omega_0} \sinh[\omega_0(t - T)]. \quad (13.218)$$

So the correct solution for this problem will be

$$z(t) = \frac{1}{\omega_0} \int_{-\infty}^t f(T) \sinh[\omega_0(t - T)] dT. \quad (13.219)$$

Note the changed upper limit in the integral: forces applied in the future cannot affect the solution at time t . We see that the response, $z(t)$, will diverge as t increases, which is physically reasonable: the system has homogeneous modes that either grow or decline exponentially with time. Special care with boundary conditions would be needed if we wanted to excite only the decaying solution – in other words, this system is unstable. This can be seen by supposing that $f(T)$ vanishes for time T_{\max} . When t is large enough, $\sinh[\omega_0(t - T)] \simeq \exp[\omega_0(t - T)]/2$ and the $\exp[\omega_0 t]$ behaviour factorises out.

FOURIER ANALYSIS: LECTURE 17

14 Partial Differential Equations and Fourier methods

The final element of this course is a look at partial differential equations. We will contrast the Fourier point of view with other techniques that are commonly employed to solve these problems.

14.1 Examples of important PDEs

PDEs are very common and important in physics. Here, we will illustrate the methods under study with four key examples:

$$\text{Poisson's equation : } \nabla^2\psi = 4\pi G\rho \quad (14.220)$$

$$\text{The wave equation : } \nabla^2\psi = \frac{1}{c^2} \frac{\partial^2\psi}{\partial t^2} \quad (14.221)$$

$$\text{The diffusion equation : } \nabla^2\psi = \frac{1}{D} \frac{\partial\psi}{\partial t} \quad (14.222)$$

$$\text{Schrödinger's equation : } \frac{-\hbar^2}{2m}\nabla^2\psi + V\psi = i\hbar \frac{\partial\psi}{\partial t} \quad (14.223)$$

These are all examples in 3D, involving the ‘del’ vector operator

$$\nabla \equiv (\partial/\partial x, \partial/\partial y, \partial/\partial z), \quad (14.224)$$

and ∇^2 means $\nabla \cdot \nabla$. For simplicity, we will often consider the 1D analogue, in which $\psi(\mathbf{r}, t)$ depends only on x and t , so that ∇^2 is replaced by $\partial^2/\partial x^2$.

14.1.1 Poisson's equation

This is the equation that relates the gravitational potential (usually written Φ) to the density of matter, ρ . The potential dictates the acceleration of a body via $\mathbf{a} = -\nabla\Phi$. Thus, Poisson's equation says $\nabla \cdot \mathbf{a} = -4\pi G\rho$. A very similar equation applies in electrostatics: $\nabla^2\Phi = -\rho/\epsilon_0$, where ρ is the charge density, and now $\mathbf{a} = -(q/m)\nabla\Phi$. Note the sign difference: gravity attracts, but like charges repel. Poisson's equation is derived by considering a point mass, $\rho = M\delta(\mathbf{x})$, which we know gives an inverse-square acceleration, $\mathbf{a} = -(GM/r^2)\hat{\mathbf{r}}$ (pointing radially inwards). If we integrate both sides over volume out to radius r , the rhs gives just $4\pi GM$ whereas the lhs gives (via the divergence theorem) the area integral $\int \mathbf{a} \cdot \mathbf{dA}$. Since the total area is $4\pi r^2$, this integral is also $4\pi GM$. So Poisson's equation is satisfied by a single particle, and by linearity it is satisfied by any system of particles.

14.1.2 The wave equation

A simple way to see the form of the wave equation is to consider a single plane wave, represented by $\psi = \exp[i(\mathbf{k} \cdot \mathbf{x} - \omega t)]$. We have $\nabla^2\psi = -k^2\psi$, and $(\partial^2/\partial t^2)\psi = -\omega^2\psi$. Since $\omega/|\mathbf{k}| = c$, this

one mode satisfies the wave equation. But a general ψ can be created by superposition of different waves (as in Fourier analysis), so ψ also satisfies the equation. Exactly the same reasoning is used in deriving Schrödinger's equation. Here we use de Broglie's relations for momentum and energy:

$$\mathbf{p} = \hbar\mathbf{k}; \quad E = \hbar\omega. \quad (14.225)$$

Then the nonrelativistic energy-momentum relation, $E = p^2/2m + V$ becomes $\hbar\omega = (\hbar^2/2m)k^2 + V$. A single wave therefore obeys Schrödinger's equation, and by superposition and completeness, so does a general ψ .

14.1.3 The diffusion equation

The diffusion equation is important because it describes how heat and particles get transported, (typically) under conduction. For completeness, here is a derivation – although this is non-examinable in this course.

The heat flux density (energy per second crossing unit area of surface) is assumed to be proportional to the gradient of the temperature (which we will call u):

$$f(x, t) = -\lambda \frac{\partial u(x, t)}{\partial x}, \quad (14.226)$$

where λ is a constant (the thermal conductivity). The minus sign is there because if the temperature gradient is positive, then heat flows towards negative x .

Now consider a thin slice of width δx from x to $x + \delta x$: there is energy flowing in at the left which is (per unit area) $f(x)$, and energy is flowing out to the right at a rate $f(x + \delta x)$. So in time δt , for unit area of surface, the energy content increases by an amount

$$\delta Q = \delta t [f(x) - f(x + \delta x)] \simeq -\delta t \delta x (\partial f / \partial x), \quad (14.227)$$

where we have made a Taylor expansion $f(x + \delta x) = f(x) + \delta x (\partial f / \partial x) + O([\delta x]^2)$. This heats the gas. The temperature rise is proportional to the energy added per unit volume,

$$\delta u = c \frac{\delta Q}{\delta V} \quad (14.228)$$

where the constant of proportionality c here is called the specific heat capacity. $\delta V = \delta x$ is the volume of the slice (remember it has unit area cross-section). Dividing by Δt then gives the diffusion equation:

$$\delta u = -c \left[\frac{\partial f}{\partial x} \delta x \right] \delta t \frac{1}{\delta V} = c\lambda \frac{\partial^2 u}{\partial x^2} \delta t \quad \Rightarrow \quad \frac{\partial u}{\partial t} = \kappa \frac{\partial^2 u}{\partial x^2} \quad (14.229)$$

(for a constant $\kappa = c\lambda$). We often write κ as D , the *diffusion coefficient*. This same equation applies to the evolution of concentrations of particle number density.

In 3D, this generalises to

$$\frac{\partial u}{\partial t} = \kappa \nabla^2 u. \quad (14.230)$$

The heat transport relation $f = -\lambda(\partial u / \partial x)$ takes a vector form $\mathbf{f} = -\lambda \nabla u$, which is just a flow in the direction of maximum temperature gradient, but otherwise identical to the 1D case. When there is a flux-density vector in 3D, the corresponding density, ρ , obeys the *continuity equation*, $\nabla \cdot \mathbf{f} = -\partial \rho / \partial t$. Since the change in temperature is c times the change in heat density, this gives the above 3D heat equation.

14.2 Solving PDEs with Fourier methods

The Fourier transform is a linear operation, which can be applied to transform a PDE (e.g. from x to k) – often leading to simpler equations (algebraic or ODE typically) for the integral transform of the unknown function. This is because spatial derivatives turn into factors of ik . Similar behaviour is seen in higher numbers of dimensions. When ψ is a single Fourier mode, then

$$1\text{D} : \quad \frac{\partial}{\partial x}\psi \rightarrow ik\psi; \quad \frac{\partial^2}{\partial x^2}\psi \rightarrow -k^2\psi \quad (14.231)$$

$$3\text{D} : \quad \nabla\psi \rightarrow i\mathbf{k}\psi; \quad \nabla^2\psi \rightarrow -k^2\psi. \quad (14.232)$$

These simpler equations are then solved and the answer transformed back to give the required solution. This is just the method we used to solve ordinary differential equations, but with the difference that there is still a differential equation to solve in the untransformed variable. Note that we can choose whether to Fourier transform from \mathbf{x} to \mathbf{k} , resulting in equations that are still functions of t , or we can transform from t to ω , or we can transform both. Both routes should work, but normally we would choose to transform away the higher derivative (e.g. the spatial derivative, for the diffusion equation).

The FT method works best for infinite systems. In subsequent lectures, we will see how Fourier series are better able to incorporate boundary conditions.

14.2.1 Example: Poisson's equation

This equation is particularly simple to solve in Fourier space as it is independent of time. Even though it is a partial differential equation, we can solve it in a single operation by taking the multidimensional Fourier transform:

$$\nabla^2\Phi = 4\pi G\rho \Rightarrow -|\mathbf{k}|^2\tilde{\Phi} = 4\pi G\tilde{\rho}. \quad (14.233)$$

This is the basis of a simple general algorithm for finding gravitational fields: sample the density on a mesh and apply the discrete Fourier transform; divide the mode amplitudes by k^2 and invert the transform. Better still, the same approach works in converting from the potential to accelerations: $\mathbf{a} = -\nabla\Phi \Rightarrow \tilde{a}_x = ik_x\tilde{\Phi}$. Thus the three components of the acceleration are derived by performing three inverse Fourier transforms.

14.2.2 Example: the diffusion equation

Now consider using Fourier methods to solve the diffusion equation for an *infinite system*.

$$\frac{\partial^2 n(x, t)}{\partial x^2} = \frac{1}{D} \frac{\partial n(x, t)}{\partial t}. \quad (14.234)$$

The diffusion coefficient D is assumed to be independent of position. This is important, otherwise the FT method is not so useful. The procedure is as follows:

- FT each side: Multiply by e^{-ikx} and integrate over $-\infty < x < \infty$
- Write the (spatial) FT of $n(x, t)$ as $\tilde{n}(k, t)$
- Pull the temporal derivative outside the integral over x

- Use Eqn. (12.134) with $p = 2$ to get:

$$(ik)^2 \tilde{n}(k, t) = \frac{1}{D} \frac{\partial \tilde{n}(k, t)}{\partial t} \quad (14.235)$$

- This is true for each value of k (k is a continuous variable). This is a partial differential equation, but let us for now fix k , so we have a simple ODE involving a time derivative, and we note that $d(\ln \tilde{n}) = d\tilde{n}/\tilde{n}$, so we need to solve

$$\frac{d \ln \tilde{n}}{dt} = -k^2 D. \quad (14.236)$$

Its solution is $\ln \tilde{n}(k, t) = -k^2 Dt + \text{constant}$. Note that the constant can be different for different values of k , so the general solution is

$$\tilde{n}(k, t) = \tilde{n}_0(k) e^{-Dk^2 t}. \quad (14.237)$$

where $\tilde{n}_0(k) \equiv \tilde{n}(k, t = 0)$, to be determined by the initial conditions.

- The answer (i.e. general solution) comes via an inverse FT:

$$n(x, t) = \int_{-\infty}^{\infty} \frac{dk}{2\pi} \tilde{n}(k, t) e^{ikx} = \int_{-\infty}^{\infty} \frac{dk}{2\pi} \tilde{n}_0(k) e^{ikx - Dk^2 t}. \quad (14.238)$$

SPECIFIC EXAMPLE: We add a small drop of ink to a large tank of water (assumed 1-dimensional). We want to find the density of ink as a function of space and time, $n(x, t)$.

Initially, all the ink (S particles) is concentrated at one point (call it the origin):

$$n(x, t = 0) = S \delta(x) \quad (14.239)$$

implying (using the sifting property of the Dirac delta function),

$$\tilde{n}_0(k) \equiv \tilde{n}(k, 0) = \int_{-\infty}^{\infty} dx n(x, t = 0) e^{-ikx} = \int_{-\infty}^{\infty} dx \delta(x) e^{-ikx} = S. \quad (14.240)$$

Putting this into Eqn. (14.238) we get:

$$\begin{aligned} n(x, t) &= \int_{-\infty}^{\infty} \frac{dk}{2\pi} \tilde{n}(k, t) e^{ikx} = \int_{-\infty}^{\infty} \frac{dk}{2\pi} \tilde{n}_0(k) e^{ikx - Dk^2 t} \\ &= \int_{-\infty}^{\infty} \frac{dk}{2\pi} S e^{ikx - Dk^2 t} = \frac{S}{\sqrt{2\pi\sqrt{2Dt}}} e^{-x^2/(4Dt)}. \end{aligned} \quad (14.241)$$

(we used the ‘completing the square’ trick that we previously used to FT the Gaussian). Compare this with the usual expression for a Gaussian,

$$\frac{1}{\sqrt{2\pi\sigma}} \exp\left(-\frac{x^2}{2\sigma^2}\right) \quad (14.242)$$

and identify the width σ with $\sqrt{2Dt}$.

So, the ink spreads out with concentration described by a normalized Gaussian centred on the origin with width $\sigma = \sqrt{2Dt}$. The important features are:

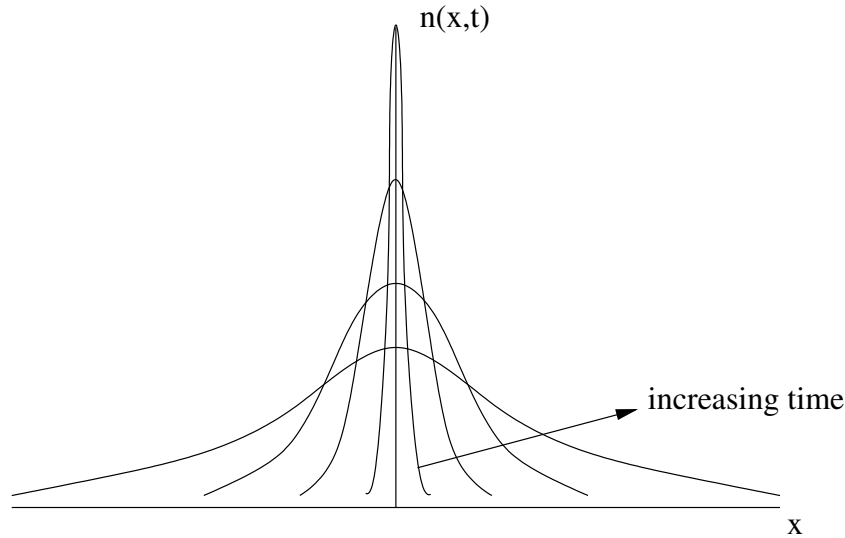

Figure 14.15: Variation of concentration with distance x at various diffusion times.

- normalized: there are always S particles in total at every value of t
- centred on the origin: where we placed the initial drop
- width $\sigma = \sqrt{2Dt}$: gets broader as time increases
 - $\sigma \propto \sqrt{t}$: characteristic of random walk ('stochastic') process
 - $\sigma \propto \sqrt{D}$: if we increase the diffusion constant D , the ink spreads out more quickly.

The solution $n(x, t)$ is sketched for various t in Fig. 14.15.

14.3 Fourier solution of the wave equation

One is used to thinking of solutions to the wave equation being sinusoidal, but they don't have to be. We can use Fourier Transforms to show this rather elegantly, applying a partial FT ($x \rightarrow k$, but keeping t as is).

The wave equation is

$$c^2 \frac{\partial^2 u(x, t)}{\partial x^2} = \frac{\partial^2 u(x, t)}{\partial t^2} \quad (14.243)$$

where c is the wave speed. We Fourier Transform w.r.t. x to get $\tilde{u}(k, t)$ (note the arguments), remembering that the FT of $\partial^2/\partial x^2$ is $-k^2$:

$$-c^2 k^2 \tilde{u}(k, t) = \frac{\partial^2 \tilde{u}(k, t)}{\partial t^2}. \quad (14.244)$$

This is a harmonic equation for $\tilde{u}(k, t)$, with solution

$$\tilde{u}(k, t) = Ae^{-ikct} + Be^{ikct} \quad (14.245)$$

However, because the derivatives are partial derivatives, the 'constants' A and B can be functions of k . Let us write these arbitrary functions as $\tilde{f}(k)$ and $\tilde{g}(k)$, i.e.

$$\tilde{u}(k, t) = \tilde{f}(k)e^{-ikct} + \tilde{g}(k)e^{ikct}. \quad (14.246)$$

We now invert the transform, to give

$$\begin{aligned}u(x, t) &= \int_{-\infty}^{\infty} \frac{dk}{2\pi} [\tilde{f}(k)e^{-ikct} + \tilde{g}(k)e^{ikct}] e^{ikx} \\ &= \int_{-\infty}^{\infty} \frac{dk}{2\pi} \tilde{f}(k)e^{ik(x-ct)} + \int_{-\infty}^{\infty} \frac{dk}{2\pi} \tilde{g}(k)e^{ik(x+ct)} \\ &= f(x - ct) + g(x + ct)\end{aligned}$$

and f and g are arbitrary functions.

FOURIER ANALYSIS: LECTURE 18

15 Separation of Variables

We now contrast the approach of Fourier transforming the equations with another standard technique. If we have a partial differential equation for a function which depends on several variables, e.g. $u(x, y, z, t)$, then we can attempt to find a solution which is *separable* in the variables:

$$u(x, y, z, t) = X(x)Y(y)Z(z)T(t) \quad (15.247)$$

where X, Y, Z, T are some functions of their arguments, and we try to work out what these functions are. Examples of separable functions are xyz^2e^{-t} , $x^2 \sin(y)(1+z^2)t$, but not $(x^2+y^2)zt$. Not all PDEs have separable solutions, but many physically important examples do.

15.1 Example of 1D wave equation

Let us consider the 1D wave equation (so we have only x and t as variables) as an example:

$$\frac{\partial^2 u}{\partial x^2} = \frac{1}{c^2} \frac{\partial^2 u}{\partial t^2}. \quad (15.248)$$

We try a solution $u(x, t) = X(x)T(t)$:

$$\frac{\partial^2(XT)}{\partial x^2} = \frac{1}{c^2} \frac{\partial^2(XT)}{\partial t^2}. \quad (15.249)$$

Now notice that on the lhs, T is not a function of x , so can come outside the derivative, and also, since X is a function of x only, the *partial* derivative with respect to x is the same as the *ordinary* derivative. A similar argument holds on the rhs, where X is not a function of t , so

$$T \frac{d^2 X}{dx^2} = \frac{X}{c^2} \frac{d^2 T}{dt^2}. \quad (15.250)$$

The trick here is to divide by XT , to get

$$\frac{1}{X} \frac{d^2 X}{dx^2} = \frac{1}{c^2 T} \frac{d^2 T}{dt^2}. \quad (15.251)$$

Now, the left hand side is not a function of t (only of x), whereas the right hand side is not a function of x (only of t). The only way these two independent quantities can be equal for all t and x is if they are both constant. The constant is called the *separation constant*, and let us call it $-k^2$ (if it turns out to be positive, we'll come back and call it k^2 , or, alternatively, let k be imaginary). Hence the equation for X is (multiplying by X)

$$\frac{d^2 X}{dx^2} = -k^2 X. \quad (15.252)$$

You know the solution to this: $X(x) = A \exp(ikx) + B \exp(-ikx)$, for constants A and B (alternatively, we can write X as a sum of sines and cosines).

The equation for T is

$$\frac{1}{c^2} \frac{d^2 T}{dt^2} = -k^2 T \quad (15.253)$$

which has solution $T(t) = C \exp(i\omega t) + D \exp(-i\omega t)$, where $\omega = ck$. If we take in particular $B = C = 0$ and $A = D = 1$, we have a solution

$$u(x, t) = \exp[i(kx - \omega t)] \quad (15.254)$$

which is as a sinusoidal wave travelling in the $+x$ direction. In general, we will get a mixture of this and $\exp[i(kx + \omega t)]$, which is a sinusoidal wave travelling in the negative x direction. We will also get the same exponentials with the opposite sign in the exponent. These could be combined into

$$u(x, t) = A \sin[(kx - \omega t) + \alpha] + B \sin[(kx - \omega t) + \beta], \quad (15.255)$$

which is a mixture of waves travelling in the two directions, with different phases.

IMPORTANT: Notice that we can add together any number of solutions with different values of the separation constant $-k^2$, and we will still satisfy the equation. This means that the full solution can be a more complicated non-periodic function, and we saw above that the general solution of the 1D wave equation is

$$u(x, t) = f(x - ct) + g(x + ct), \quad (15.256)$$

for *any* (twice-differentiable) functions f and g .

15.2 Eigenvalues and boundary conditions

The separation equations have the form of an *eigenvalue* problem, where $X(x)$ must be an *eigenfunction* of the *differential operator* d^2/dx^2 with *eigenvalue* $-k^2$. This should be familiar terminology from quantum mechanics. The exact form of the eigenfunctions is dictated by boundary conditions, which need to be *homogeneous*, i.e. in the form $u = 0$ for some combination of time and space (commonly as a function of space at $t = 0$). This is because we want to build a general solution by superposition, and sums of terms only keep the boundary condition unchanged if it is zero. If the condition is $u = \text{const}$, we can convert it to $u = 0$ by writing a PDE for $u - \text{const}$ instead.

For example, consider the 1D wave equation as representing the transverse displacement of a plucked string of length L . The boundary conditions are that the string is fixed at either end:

$$u(x = 0, t) = u(x = L, t) = 0 \quad (15.257)$$

for all t . Because these BCs hold for all times at specific x , they affect $X(x)$ rather than $T(t)$:

$$X(x) \propto \sin kx; \quad k = n\pi x/L, \quad n = 0, 1, 2 \dots \quad (15.258)$$

Here, BCs have restricted the allowed values of k and thus the allowed frequencies of oscillation. Different boundary conditions will have different allowed values. Restriction of eigenvalues by boundary conditions is a very general property in physics:

finite boundaries \Rightarrow discrete (quantised) eigenvalue spectrum \Rightarrow allowable separation constants.

Each n value corresponds to a *normal mode* of the string:

$$u(x, t) = A_n \sin k_n x \{C_n \sin \omega_n t + D_n \cos \omega_n t\}. \quad (15.259)$$

A normal mode is an excitation that obeys the BCs and oscillates with a single frequency. We sometimes call these *eigenmodes* of the system, with associated *eigenfrequencies* $\omega_n = \omega_{k_n}$.

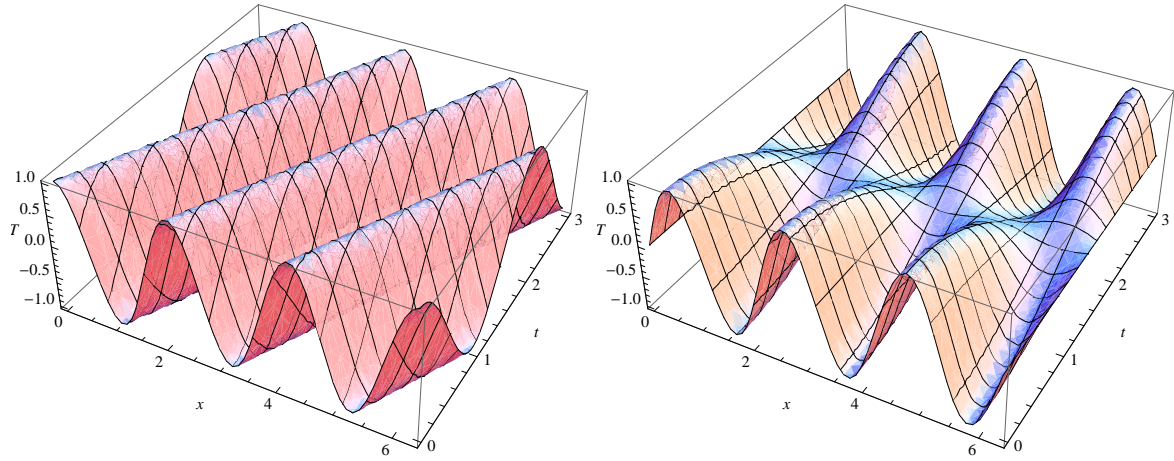

Figure 15.16: Contrasting the travelling-wave and standing-wave solutions to the wave equation.

15.2.1 Standing waves

Here is another example. If we require that u is zero at two boundaries $x = (0, \pi)$, and that at $t = 0$ the solution is a sin wave, $u(x, 0) = \sin(3x)$, then the solution is $u(x, t) = \sin(3x) \cos(3ct)$. This is a *standing wave*, which does not propagate, just varies its amplitude with time.

Note that we can write the standing wave solution as a superposition of waves travelling in opposite directions (with $ck = \omega$):

$$\begin{aligned}
 \sin(kx) \cos(\omega t) &= \frac{1}{2i}(e^{ikx} - e^{-ikx}) \frac{1}{2}(e^{i\omega t} + e^{-i\omega t}) \\
 &= \frac{1}{4i} [e^{i(kx+\omega t)} + e^{i(kx-\omega t)} - e^{-i(kx-\omega t)} - e^{-i(kx+\omega t)}] \\
 &= \frac{1}{2} [\sin(kx + \omega t) + \sin(kx - \omega t)].
 \end{aligned} \tag{15.260}$$

15.3 Solving the diffusion equation via separation of variables

Let us now try to solve the diffusion equation in 1D:

$$\frac{\partial^2 u}{\partial x^2} = \frac{1}{\kappa} \frac{\partial u}{\partial t}. \tag{15.261}$$

We wish to find a solution with $u \rightarrow 0$ as $t \rightarrow \infty$. We try separating variables, $u(x, t) = X(x)T(t)$, to find

$$\frac{1}{X} \frac{d^2 X}{dx^2} = \frac{1}{\kappa T} \frac{dT}{dt} = -\lambda^2 \tag{15.262}$$

where we have written the separation constant as $-\lambda^2$. The equation for X is the same as we had before. This time, let us write the solution as sines and cosines:

$$X(x) = A \sin(\lambda x) + B \cos(\lambda x). \tag{15.263}$$

The equation for T is

$$\frac{dT}{dt} = -\lambda^2 \kappa T, \tag{15.264}$$

or

$$\frac{d \ln T}{dt} = -\lambda^2 \kappa \quad (15.265)$$

which has solution

$$T(t) = C \exp(-\lambda^2 \kappa t) \quad (15.266)$$

so we have a separable solution (absorbing the constant C into A and B)

$$u(x, t) = [A \sin(\lambda x) + B \cos(\lambda x)] \exp(-\lambda^2 \kappa t), \quad (15.267)$$

This tends to zero as $t \rightarrow \infty$ provided $\lambda^2 > 0$. With $\lambda^2 < 0$, the spatial variation would be a combination of sinh and cosh terms; these functions do not oscillate, so it is not possible to satisfy homogeneous boundary conditions. Therefore we have to consider only $\lambda^2 > 0$. This is physically reassuring, since the solution that diverges exponentially with time hardly feels intuitively correct, and indeed it conflicts with our previous solution of the diffusion equation by Fourier methods.

Note that we can add solutions with different λ . At a given time, this will amount to writing the spatial dependence as something resembling a Fourier series:

$$u(x, t) = \sum_i [A(t) \sin(\lambda_i x) + B(t) \cos(\lambda_i x)]. \quad (15.268)$$

The allowed λ_i depend on the boundary conditions. Suppose these are $u(x = a) = u(x = a + L) = 0$ (for all t): then we have

$$\lambda_n = n\pi/L; \quad n = 1, 2, \dots \quad (15.269)$$

The easiest way to see this is choose our coordinates so that $a = 0$, in which case $B = 0$ and $\sin(\lambda L) = 0$. This differs from Fourier series as we have studied them in two ways. Firstly, the allowed wavenumbers are as we would have written them for a periodic function with a fundamental period of $2L$, whereas here we are interested in a solution just in a range of length L . In reality, the solution will be zero outside this range (imagine a system immersed in a heat bath that imposes the boundary conditions at either end). But what happens outside $x = a$ to $x = a + L$ has no impact on the solution inside: only the requirement for $u = 0$ at the boundary matters. Therefore we can write down the Fourier series and use it inside the range of interest, even though it makes an incorrect prediction outside.

Because this is not a normal Fourier series, we need care in using orthogonality to extract the coefficients:

$$\int_a^{a+L} \sin(\lambda_i x) \sin(\lambda_j x) dx \neq (L/2) \delta_{ij} \quad (15.270)$$

etc. This is because the range L is only an integral multiple of *half* a wavelength, rather than a multiple of a wavelength as before, with the result that the sine and cosine coefficients are not independent. But some sort of orthogonality relation still applies; again, this is most simply seen by choosing $a = 0$, in which case only sine waves are used, and it is easy to see that these are orthogonal.

The other distinction from a normal Fourier series is that there is no constant term. But what if we wanted to impose some non-zero temperature at either end of the interval? The answer is that we can always add a constant to any solution of the diffusion equation; so when we speak of a boundary condition involving $u = 0$, this really means the temperature is at some uniform average value, which we do not need to specify. This is just as well, since the oscillating solution apparently allows negative temperatures, which would be unphysical.

FOURIER ANALYSIS: LECTURE 19

15.4 Separation of variables in 2D: the diffusion equation

We now extend this analysis of the diffusion equation to more than one spatial dimension. Consider an infinite square column of side L which is initially at temperature T_0 , $u(x, y, t = 0) = 0$. At $t = 0$ it is immersed in a heat bath at temperature T_b . To achieve homogeneous boundary conditions, we define $u(x, y)$ as temperature minus T_b (no z dependence, by symmetry). The diffusion equation only applies inside the column, but the value of u outside the column has no effect on the solution for the temperature inside, beyond the boundary condition of $u = 0$ at the edge, so we can ignore the fact that our mathematical solution makes an (incorrect) prediction for the temperature variation outside the column.

We look for separable solutions of the heat equation:

$$\nabla^2 u = \frac{1}{\kappa} \frac{\partial u}{\partial t}; \quad u(x, y, t) = X(x)Y(y)T(t). \quad (15.271)$$

With this substitution, the differential equation becomes

$$YT \frac{d^2 X}{dx^2} + XT \frac{d^2 Y}{dy^2} - \frac{XYZ}{\kappa} \frac{dT}{dt} = 0. \quad (15.272)$$

Dividing by XYT , we get

$$\frac{1}{X} \frac{d^2 X}{dx^2} + \frac{1}{Y} \frac{d^2 Y}{dy^2} - \frac{1}{\kappa T} \frac{dT}{dt} = 0. \quad (15.273)$$

Since each term depends on a single variable, they must all be constant, e.g.

$$\frac{1}{\kappa T} \frac{dT}{dt} = -\lambda \quad \Rightarrow \quad T(t) \propto e^{-\lambda \kappa t}. \quad (15.274)$$

We next find the equation for X , by isolating terms which depend on x only:

$$\frac{1}{X} \frac{d^2 X}{dx^2} = -\frac{1}{Y} \frac{d^2 Y}{dy^2} - \lambda = -k_x^2 = \text{constant}. \quad (15.275)$$

The X equation is easy to solve:

$$\frac{d^2 X}{dx^2} = -k_x^2 X \quad \Rightarrow \quad X(x) = Ae^{ik_x x} + Be^{-ik_x x} \quad (15.276)$$

and similarly for Y – except that the equivalent wavenumber k_y must satisfy $k_x^2 + k_y^2 = \lambda$, from equation (15.275).

Now, as stated above, the terms we calculate here must be zero on the boundaries at $x = 0, L$, $y = 0, L$. Hence the solutions for X and Y must be sinusoidal, with the correct period, e.g.

$$X(x) \propto \sin\left(\frac{m\pi x}{L}\right) \quad (15.277)$$

for any integer m . Similarly for Y . So a separable solution is

$$u(x, y, t) = T_0 + C_{mn} \sin\left(\frac{m\pi x}{L}\right) \sin\left(\frac{n\pi y}{L}\right) e^{-\lambda_{mn} \kappa t} \quad (15.278)$$

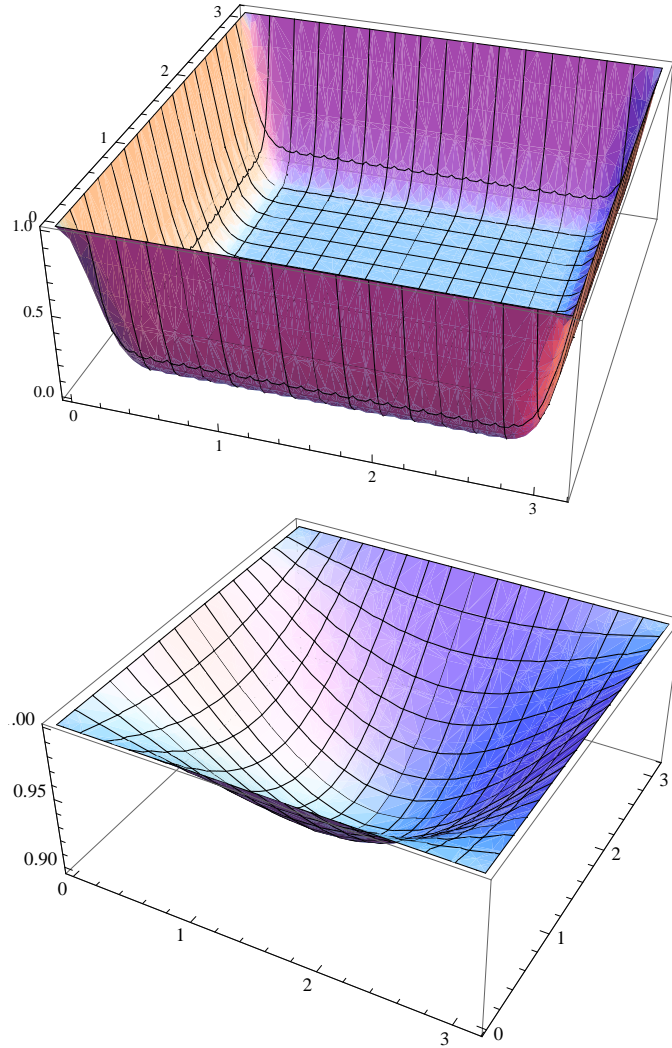

Figure 15.17: Temperature at an early time $t = 0.01$, for $T_0 = 1$, $\kappa = 1$ and $L = \pi$, and then at a late time $t = 1$.

where

$$\lambda_{mn} = \frac{\pi^2}{L^2}(m^2 + n^2). \quad (15.279)$$

Here we have identified the separation constants explicitly with the integers m, n , rewriting $\lambda = k_x^2 + k_y^2$.

Now we can add the separable solutions:

$$u(x, y, t) = \sum_{m,n=0}^{\infty} C_{mn} \sin\left(\frac{m\pi x}{L}\right) \sin\left(\frac{n\pi y}{L}\right) e^{-\lambda_{mn}kt}. \quad (15.280)$$

All that remains is to determine the constants C_{mn} . We use the initial condition that inside the volume $u = T_0 - T_b$ when $t = 0$ (when the exponential term is unity), so

$$\sum_{m,n=0}^{\infty} C_{mn} \sin\left(\frac{m\pi x}{L}\right) \sin\left(\frac{n\pi y}{L}\right) = T_0 - T_b. \quad (15.281)$$

This looks very much like a Fourier Series, and we can use the same trick of the orthogonality of the sin functions. Multiply by $\sin(m'\pi x/L)$ and integrate with respect to x , giving 0 unless $m = m'$,

and $L/2$ if $m = m'$. Similarly for y , so

$$\begin{aligned} C_{mn} \left(\frac{L}{2}\right)^2 &= (T_0 - T_b) \int_0^L \sin(m\pi x/L) dx \int_0^L \sin(n\pi y/L) dy \\ &= (T_0 - T_b) \left[-\frac{L}{m\pi} \cos\left(\frac{m\pi x}{L}\right) \right]_0^L \left[-\frac{L}{n\pi} \cos\left(\frac{n\pi y}{L}\right) \right]_0^L. \end{aligned} \quad (15.282)$$

The cosines are zero if m, n are even. If m, n are both odd, the right hand side is $4L^2/(mn\pi^2)$, from which we get

$$C_{mn} = \begin{cases} 16(T_0 - T_b)/(\pi^2 mn) & m, n \text{ all odd} \\ 0 & \text{otherwise} \end{cases} \quad (15.283)$$

Finally the full solution is

$$u(x, y, t) = (T_0 - T_b) \left\{ \frac{16}{\pi^2} \sum_{m, n \text{ odd}} \frac{1}{mn} \sin\left(\frac{m\pi x}{L}\right) \sin\left(\frac{n\pi y}{L}\right) \exp\left[-(m^2 + n^2) \frac{\kappa\pi^2 t}{L^2}\right] \right\}. \quad (15.284)$$

15.5 Separation of variables in 2D: the Schrödinger equation

A similar problem arises when we consider the time-dependent Schrödinger equation in 2D, for a particle trapped in a (zero) potential 2D square well with infinite potentials on walls at $x = 0, L$, $y = 0, L$. The infinite potential forces the wave function to vanish on the walls. The equation with potential $V = 0$ is valid inside the well, and again the mathematical solution outside the well with $V = 0$ will incorrectly give $\psi \neq 0$. But inside the well, the solution is independent of what happens outside; only the conditions on the boundary have an influence.

The equation to be solved is

$$-\frac{\hbar^2}{2m} \nabla^2 \psi(\mathbf{x}, t) = i\hbar \frac{\partial \psi(\mathbf{x}, t)}{\partial t}. \quad (15.285)$$

This is just the diffusion equation with an imaginary diffusion coefficient:

$$\kappa_{\text{eff}} = i \frac{\hbar}{2m}, \quad (15.286)$$

so we can immediately copy from above the solution that would result from separation of variables:

$$\psi(x, y, t) = \sum_{q, r=0}^{\infty} C_{qr} \sin\left(\frac{m\pi x}{L}\right) \sin\left(\frac{n\pi y}{L}\right) e^{-i(\hbar\lambda_{q,r}/2m)t}; \quad \lambda_{qr} = \frac{\pi^2}{L^2}(q^2 + r^2) \quad (15.287)$$

(we avoid m as an integer index, since it denotes mass). As with the diffusion equation, the C_{qr} coefficients are set by the form of the wave function at $t = 0$, which must always be normalised so that $\iint |\psi|^2 dx dy = 1$.

The time dependence of the modes is $e^{-i\omega t}$, or, in terms of energy $E = \hbar\omega$, $e^{-iEt/\hbar}$, where

$$E = \frac{\hbar^2 \lambda_{qr}}{2m} = \frac{\hbar^2 \pi^2 (q^2 + r^2)}{2mL^2} \quad q, r = 1, 2, 3, \dots \quad (15.288)$$

For a square well, the energy levels are *degenerate* – different combinations of q and r give the same energy level.

16 PDEs in curved coordinates

The final topics in these lectures is to give a taste of what happens when we move away from Cartesian spatial coordinates. The alternative of greatest interest is polar coordinates.

There are two important cases that we frequently deal with:

$$\begin{aligned} \text{Cylindrical polars: } & (x, y, z) = (r \cos \phi, r \sin \phi, z) \\ \text{Spherical polars: } & (x, y, z) = (r \sin \theta \cos \phi, r \sin \theta \sin \phi, r \cos \theta). \end{aligned} \tag{16.289}$$

The radial coordinates r in these two systems are not the same; for this reason, it is common to use ρ in cylindrical polars instead of r .

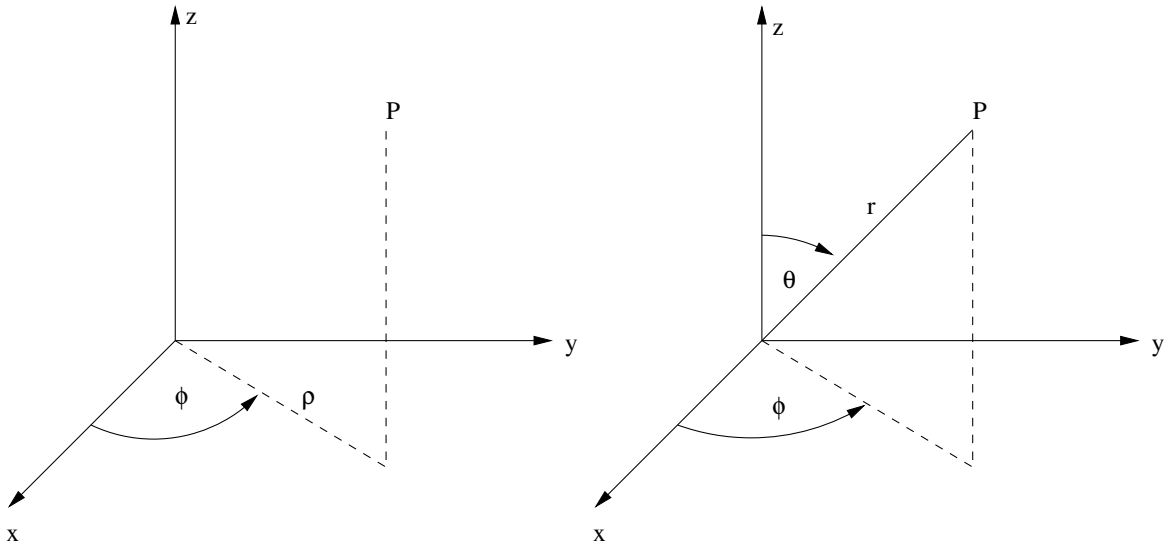

Figure 16.18: Cylindrical and spherical polar coordinates.

We now derive the form of ∇^2 in these coordinates. **This derivation is for interest, and is not examinable. But you may need to use the resulting expressions if you are given them.**

The operation of ∇ in these coordinates is complicated by the fact that the basis vectors associated with a small change in coordinates are not fixed. This is most easily seen in the 2D case of circular polars (cylindrical polars where we drop the z dependence). If we imagine locally having coordinates in the direction of increasing r or ϕ , then

$$\nabla = \mathbf{e}_r \frac{\partial}{\partial r} + \mathbf{e}_\phi \left(\frac{1}{r} \right) \frac{\partial}{\partial \phi}. \tag{16.290}$$

where \mathbf{e}_r and \mathbf{e}_ϕ are unit vectors in the directions of increasing r, ϕ . But when we rotate the coordinates, the basis vectors change. It is not too hard to be convinced of the following relations:

$$\begin{aligned} \frac{\partial}{\partial \phi} \mathbf{e}_r &= \mathbf{e}_\phi \\ \frac{\partial}{\partial \phi} \mathbf{e}_\phi &= -\mathbf{e}_r. \end{aligned} \tag{16.291}$$

Evaluating $\nabla^2 = \nabla \cdot \nabla$ now gives an additional term from the differentiation of the basis vectors:

$$\nabla^2 = \frac{1}{r^2} \frac{\partial^2}{\partial r^2} + \frac{1}{r} \frac{\partial}{\partial r} + \frac{1}{r^2} \frac{\partial^2}{\partial \phi^2}. \tag{16.292}$$

For cylindrical polars, we just have this expression plus $\partial^2/\partial z^2$.

The result in spherical polars is a little more complicated, but follows the same approach:

$$\nabla = \mathbf{e}_r \frac{\partial}{\partial r} + \mathbf{e}_\theta \left(\frac{1}{r} \right) \frac{\partial}{\partial \theta} + \mathbf{e}_\phi \left(\frac{1}{r \sin \theta} \right) \frac{\partial}{\partial \phi}. \quad (16.293)$$

There are now more terms arising via differentiation of the unit vectors, but most of these don't matter, because we always have to take the dot product at the end. For example, consider $(\mathbf{e}_r \partial/\partial r) \cdot \mathbf{T}$, where \mathbf{T} is any term. This will only be non-zero if differentiation of \mathbf{T} yields a component in the direction of \mathbf{e}_r . The only chance of doing this is through differentiating the basis vectors.

A little thought gives the following relations:

$$\begin{aligned} \frac{\partial}{\partial \theta} \mathbf{e}_r &= \mathbf{e}_\theta \\ \frac{\partial}{\partial \theta} \mathbf{e}_\theta &= -\mathbf{e}_r \\ \frac{\partial}{\partial \phi} \mathbf{e}_r &= \sin \theta \mathbf{e}_\phi \\ \frac{\partial}{\partial \phi} \mathbf{e}_\theta &= \cos \theta \mathbf{e}_\phi \\ \frac{\partial}{\partial \phi} \mathbf{e}_\phi &= -\mathbf{e}_\rho \end{aligned} \quad (16.294)$$

where \mathbf{e}_ρ is a unit vector perpendicular to the z axis, which satisfies

$$\begin{aligned} \mathbf{e}_\rho \cdot \mathbf{e}_r &= \sin \theta \\ \mathbf{e}_\rho \cdot \mathbf{e}_\theta &= \cos \theta \\ \mathbf{e}_\rho \cdot \mathbf{e}_\phi &= 0 \end{aligned} \quad (16.295)$$

We can now take the full dot product $\nabla \cdot \nabla$. This gives the three obvious terms:

$$\nabla^2 = \frac{\partial^2}{\partial r^2} + \frac{1}{r^2} \frac{\partial^2}{\partial \theta^2} + \frac{1}{r^2 \sin^2 \theta} \frac{\partial^2}{\partial \phi^2}, \quad (16.296)$$

plus extra terms from differentiating basis vectors. Since only $\partial/\partial \theta$ and $\partial/\partial \phi$ have any effect, we only care about cases where $\partial/\partial \theta$ gives a result proportional to \mathbf{e}_θ or $\partial/\partial \phi$ gives a result proportional to \mathbf{e}_ϕ . From the above, there are three such cases: (i) $\partial \mathbf{e}_r / \partial \theta$; (ii) $\partial \mathbf{e}_r / \partial \phi$; (iii) $\partial \mathbf{e}_\theta / \partial \phi$. These give additional terms that are respectively (i) $(1/r) \partial/\partial r$; (ii) $(1/r) \partial/\partial r$; (iii) $(\cot \theta / r^2) \partial/\partial \theta$.

Finally, then, ∇^2 in spherical polars is

$$\nabla^2 \psi = \frac{1}{r^2} \frac{\partial}{\partial r} \left(r^2 \frac{\partial \psi}{\partial r} \right) + \frac{1}{r^2 \sin \theta} \frac{\partial}{\partial \theta} \left(\sin \theta \frac{\partial \psi}{\partial \theta} \right) + \frac{1}{r^2 \sin^2 \theta} \frac{\partial^2 \psi}{\partial \phi^2}. \quad (16.297)$$

For a more general method of derivation, see section 8.10 of Riley, Hobson & Bence).

FOURIER ANALYSIS: LECTURE 20

16.1 Wave equation in circular polars

As an example application, consider the wave equation for a circular drum whose surface has a vertical displacement u :

$$\nabla^2 u = \frac{1}{c^2} \frac{\partial^2 u}{\partial t^2}. \quad (16.298)$$

As before, we consider solutions of separated form: $u(r, \phi, z, t) = R(r)\Phi(\phi)T(t)$. Substitute into the wave equation and divide through by $u = R\Phi T$.

$$\frac{1}{R} \frac{\partial^2 R}{\partial r^2} + \frac{1}{rR} \frac{\partial R}{\partial r} + \frac{1}{r^2\Phi} \frac{\partial^2 \Phi}{\partial \phi^2} = \frac{1}{c^2 T} \frac{\partial^2 T}{\partial t^2}. \quad (16.299)$$

First separation: time equation: $\text{LHS}(r, \phi, z) = \text{RHS}(t) = \text{constant}$

$$\frac{1}{c^2} \frac{1}{T} \frac{d^2 T}{dt^2} = -k^2. \quad (16.300)$$

The solutions to this are of the form $T(t) = G_k \cos \omega_k t + H_k \sin \omega_k t$ with $\omega_k \equiv ck$.

Second separation: Multiply through by r^2 and separate again:

$$\text{LHS}(r) = \text{RHS}(\phi) = \text{another constant}. \quad (16.301)$$

For the angular dependence:

$$\frac{1}{\Phi} \frac{d^2 \Phi}{d\phi^2} = -n^2; \quad (16.302)$$

The solution is $\Phi = C \cos n\phi + D \sin n\phi$. We want the solution to the wave equation to be *single valued*, so $\Phi(\phi + 2\pi) = \Phi(\phi)$, forcing n to be integer-valued: $n = 0, 1, 2, \dots$ (we ignore negative n as this sign can be absorbed in the coefficient D – cf. Fourier series).

The equation describing the radial dependence is the only difficult one to solve:

$$\frac{d^2 R}{dr^2} + \frac{1}{r} \frac{dR}{dr} - \frac{n^2}{r^2} R + k^2 R = 0. \quad (16.303)$$

Multiply across by r^2 and rewrite

$$r^2 R'' + rR' + (k^2 r^2 - n^2)R = 0. \quad (16.304)$$

This is known as *Bessel's equation of order n* . The solutions are known as Bessel functions. Being a quadratic ODE, there are two independent solutions called $J_n(kr)$ and $Y_n(kr)$. Note we have labelled the solutions with integer n .

16.1.1 Finding Bessel functions

We can solve Bessel's equation by substituting a general *Laurent series* as a trial solution. **This derivation is not examinable.** A Laurent series is a generalisation of a Taylor series to possibly include negative powers:

$$R(r) = \sum_{i=m}^{\infty} C_i r^i, \quad (16.305)$$

where c_i are unknown coefficients. We will suppose that there is a lowest power r^m , so that $c_i = 0$ for $i < m$. Differentiating this, we get

$$R'(r) = \sum_{i=m}^{\infty} iC_i r^{i-1} \quad (16.306)$$

$$R''(r) = \sum_{i=m}^{\infty} (i)(i-1)C_i r^{i-2} \quad (16.307)$$

$$rR'(r) = \sum_{i=m}^{\infty} iC_i r^i \quad (16.308)$$

$$r^2 R''(r) = \sum_{i=m}^{\infty} (i)(i-1)C_i r^i. \quad (16.309)$$

These combine to yield

$$\sum_{i=m}^{\infty} iC_i r^i + (i)(i-1)C_i r^i - n^2 C_i r^i + k^2 C_{i-2} r^i = 0 \quad (16.310)$$

Since this must be true for all r , Bessel's equation becomes a *recurrence relation* between coefficients and we have:

$$[i + i(i-1) - n^2] C_i + k^2 C_{i-2} = 0 \quad (16.311)$$

and so

$$[i^2 - n^2] C_i + k^2 C_{i-2} = 0 \quad (16.312)$$

The series *switches on* when $C_{i-2} = 0$ and $C_i = C_m \neq 0$, at which point we must have

$$m^2 - n^2 = 0. \quad (16.313)$$

This means that the lowest power r^m has $m = \pm n$, so there are two types of solution:

$$J_n : \text{ lowest power} = r^n; \quad Y_n : \text{ lowest power} = r^{-n}. \quad (16.314)$$

Here we seek solutions that are finite at $r = 0$, so the J_n functions are the ones we want; they can be constructed using the recurrence relation. For example, for $J_0(r)$:

$$\begin{aligned} C_0 &= 1 \\ C_2 &= -\frac{k^2}{4} \\ C_4 &= +\frac{k^4}{4.16} \\ C_6 &= -\frac{k^6}{4.16.36} \\ &\dots \end{aligned} \quad (16.315)$$

The series is

$$1 - \frac{(kr)^2}{4} + \frac{(kr)^4}{4.16} - \frac{(kr)^6}{4.16.36} \dots \quad (16.316)$$

and is purely a function of (kr) . As the sign oscillates we have many turning points. The first few J_n and Y_n functions are plotted in Fig. 16.19. The $J_n(x)$ have a series of zeros ('nodes' or 'roots') which we label $\alpha_{n1}, \alpha_{n2}, \alpha_{n3}$. Unlike trig functions, these are not equally spaced.

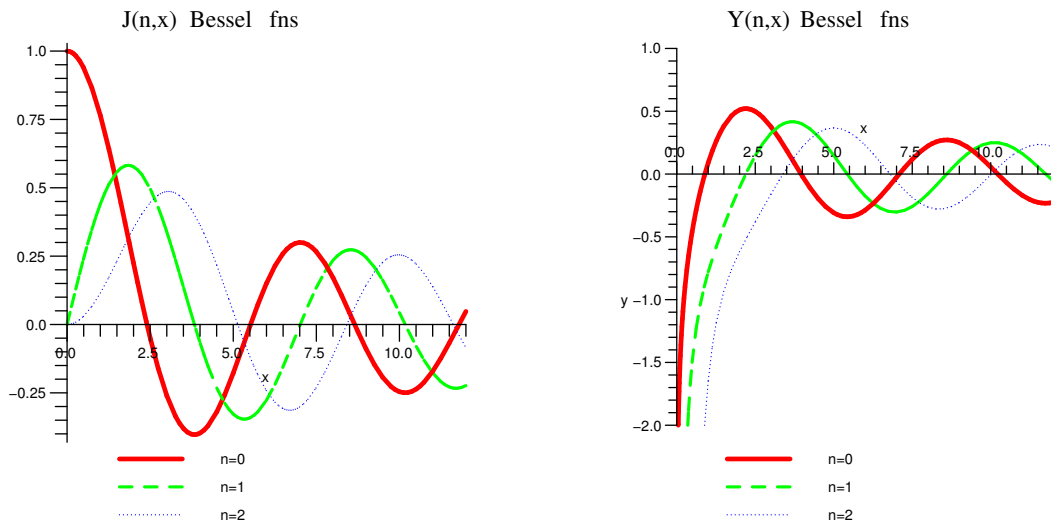

Figure 16.19: The first three Bessel functions of integral order.

Our solution can now be written as

$$u(r, \phi, t) = J_n(kr) (C \cos n\phi + D \sin n\phi) (G \cos \omega_k t + H \sin \omega_k t) \quad (16.317)$$

with $\omega_k = ck$ and currently no restriction on k . We now apply spatial boundary conditions. Recall periodicity in ϕ quantised n . In the radial direction we require that the drumskin does not move at the rim:

$$u(r = a, \phi, t) = 0 \text{ for all } \phi \text{ and } t. \quad (16.318)$$

We therefore want the edge of the drum to coincide with one of the nodes of the Bessel function. The m^{th} node of the Bessel function of order n occurs when the argument of the Bessel function takes value α_{nm} , and we rescale the Bessel function so that one of these zeros coincides with $r = a$:

$$k_{nm} = \alpha_{nm}/a. \quad (16.319)$$

Quantising k also quantises ω_k , giving the frequency spectrum of the drum.

16.1.2 Sturm–Liouville equations

Bessel functions are an example of an important general case of differential equations: the Sturm–Liouville form. The general SL equation is

$$\left[\frac{d}{dx} \left(P(x) \frac{d}{dx} \right) + Q(x) \right] \phi_i(x) = -\lambda_i \rho(x) \phi_i(x) \quad (16.320)$$

where $\phi_i(x)$ is the i -th solution with eigenvalue λ_i . The functions $P(x)$, $Q(x)$ and *weight* function $\rho(x)$ define different SL equations. For example:

| Special function | $P(x)$ | $Q(x)$ | $\rho(x)$ |
|------------------|---------------|----------|---------------|
| Sinusoid | 1 | 0 | 1 |
| Bessel | x | $-n^2/r$ | x |
| Legendre | $\sin \theta$ | 0 | $\sin \theta$ |

SL equations need boundary conditions for a solution. It is worth recording that these tend to be of three distinct types:

1. Fixed BCs (a.k.a. Dirichlet BCs):

$\phi_i(x = a) = \phi_i(x = b) = 0$ for all modes labelled by different i .
e.g. a drumskin fixed at its edge

2. Open BCs (a.k.a. Neumann BCs):

$\left. \frac{d\phi_i}{dx} \right|_{x=a} = \left. \frac{d\phi_i}{dx} \right|_{x=b} = 0$
e.g. no ink flows out of the edge of a water tank i.e. no concentration gradient.

3. Periodic BCs:

$\phi_i(x = b) = \phi_i(x = a), \left. \frac{d\phi_i}{dx} \right|_{x=b} = \left. \frac{d\phi_i}{dx} \right|_{x=a}$ and $P(x = a) = P(x = b)$.
e.g. where x is an angular variable and $a = 0, b = 2\pi$.

In these circumstances, and subject to a few further conditions, the set of solutions of SL equations always constitute a complete set – i.e. any function can be expressed as a superposition of solutions to the equation. This is the property we have assumed and exploited in Fourier series, but it is much more general.

16.2 Spherical harmonics and all that

Finally, again for non-examinable interest, we consider the special functions that arise in the context of ∇^2 in spherical polars. Consider Schrödinger's equation in 3D:

$$\left(\frac{-\hbar^2}{2m} \nabla^2 + V(\mathbf{r}) \right) \psi = E\psi, \quad (16.321)$$

and look for a factorised solution

$$\psi = R(r)\Theta(\theta)\Phi(\phi). \quad (16.322)$$

Looking at the structure of ∇^2 , we see that it can be written as

$$\nabla^2 = \frac{1}{r^2} \frac{\partial}{\partial r} \left(r^2 \frac{\partial \psi}{\partial r} \right) + \frac{1}{r^2} A^2, \quad (16.323)$$

where the operator A involves only derivatives with respect to θ and ϕ . Thus, in separation of variables, the angular part of the solution will be an eigenfunction of A – the ‘angular part’ of ∇^2 (it is actually proportional to the angular momentum operator). This equation is

$$\left[\frac{1}{\sin \theta} \frac{\partial}{\partial \theta} \left(\sin \theta \frac{\partial}{\partial \theta} \right) + \frac{1}{\sin^2 \theta} \frac{\partial^2}{\partial \phi^2} \right] \Theta(\theta)\Phi(\phi) = -\ell(\ell + 1)\Theta(\theta)\Phi(\phi). \quad (16.324)$$

The quantity ℓ turns out to be an integer – hence the slightly unobvious separation constant.

Multiplying through by $\sin^2 \theta / (\Theta\Phi)$ gives

$$-\frac{1}{\Phi} \frac{\partial^2}{\partial \phi^2} \Phi = \frac{1}{\Theta} \left[\sin \theta \frac{\partial}{\partial \theta} \left(\sin \theta \frac{\partial}{\partial \theta} \right) \right] \Theta + \ell(\ell + 1) \sin^2 \theta. \quad (16.325)$$

Yet again, we say that both sides must be constant, which we call m^2 . The solution for Φ is easy:

$$\Phi \propto \exp(im\phi) \quad (16.326)$$

and we see that m must be an integer (positive or negative) in order that the solution is unchanged under rotation by 2π .

This leaves one nasty equation for $\Theta(\theta)$:

$$\left[\frac{1}{\sin\theta} \frac{\partial}{\partial\theta} \left(\sin\theta \frac{\partial}{\partial\theta} \right) + \ell(\ell+1) - \frac{m^2}{\sin^2\theta} \right] \Theta(\theta) = 0. \quad (16.327)$$

It is normal to rewrite this in terms of $z \equiv \cos\theta$, to get

$$\frac{d}{dz} \left[(1-z^2) \frac{d\Theta}{dz} \right] + \left(\ell(\ell+1) - \frac{m^2}{1-z^2} \right) \Theta = 0. \quad (16.328)$$

This is a standard equation, whose solutions are the *associated Legendre functions*, P_ℓ^m . The equation with $m = 0$ can be solved by the usual technique of power-law solution, since the nasty $1/(1-z^2)$ term is removed:

$$\Theta(z) = \sum_{k=0}^{\infty} a_k z^k. \quad (16.329)$$

The resulting recurrence relation is

$$(k+1)(k+2)a_{k+2} = [k(k+1) - \ell(\ell+1)]a_k, \quad (16.330)$$

so the solution splits into two independent series, odd and even; one of these terminates at $k = k_{\max}$ if ℓ is chosen to be an integer $\ell = k_{\max}$, and the other series is set to zero. If the series doesn't terminate, then it diverges at $z = \pm 1$, and this solution would never be required in order to represent a finite wave function.

The solutions are then the *Legendre polynomials*, $P_\ell(z)$. These are specified up to an overall normalization, which is taken to be $P_\ell(1) = 1$. This means that the spatial wavefunctions are *not* normalized. The first few Legendre polynomials are:

$$\begin{aligned} P_0(x) &= 1 \\ P_1(x) &= x \\ P_2(x) &= (3x^2 - 1)/2 \\ P_3(x) &= (5x^3 - 3x)/2 \end{aligned} \quad (16.331)$$

(see e.g. p453 of Riley, Hobson & Bence). For the full solution, it can be shown that the following modifications of the Legendre polynomials work:

$$P_\ell^m(z) = (1-z^2)^{|m|/2} \frac{d^{|m|}}{dz^{|m|}} P_\ell(z), \quad (16.332)$$

from which we see that $|m| \leq \ell$. This defines the associated Legendre polynomials.

In summary, the overall angular solutions are the *spherical harmonics*. With the correct normalization, these are defined for $m \geq 0$ as

$$Y_\ell^m = (-1)^m \sqrt{\frac{(2\ell+1)(\ell-m)!}{4\pi(\ell+m)!}} P_\ell^m(\cos\theta) e^{im\phi}; \quad (16.333)$$

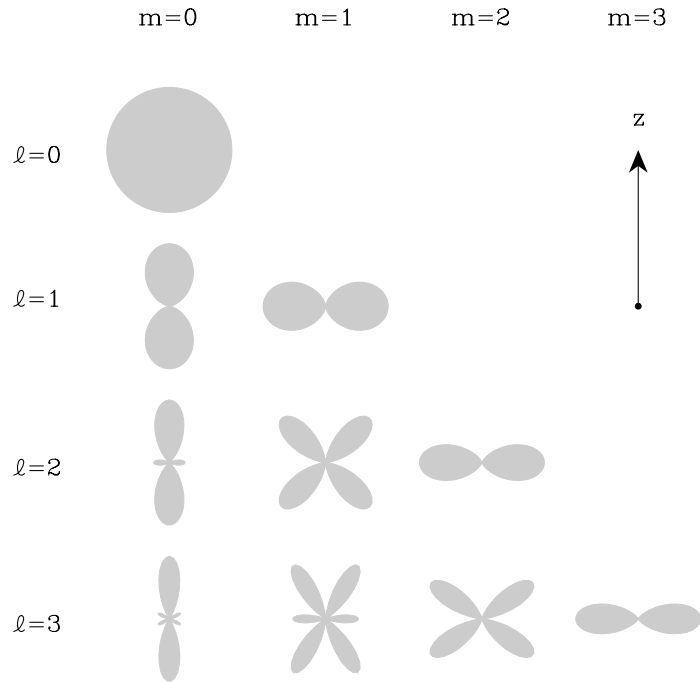

Figure 16.20: The low-order angular eigenfunctions of ∇^2 . The radius of these ‘polar-diagram’ patterns is proportional to $|Y_\ell^m|^2$.

For negative m , $Y_\ell^{-|m|} = (-1)^{|m|}(Y_\ell^m)^*$, so harmonics with positive and negative m are identical apart from a (conventional) overall sign and the sign of the $e^{im\phi}$ term. No-one with any sense would try to remember the exact coefficient here. The main thing is that the spherical harmonics are orthonormal over the unit sphere:

$$\int Y_\ell^{m*} Y_{\ell'}^{m'} d\Omega = \delta_{\ell\ell'} \delta_{mm'} \quad (16.334)$$

($d\Omega$ being an element of solid angle), and so they give a complete description of the angular variation of the wavefunction. They are the analogue of Fourier harmonics on the surface of a sphere.